

Panasonic®

Palmcorder IQ®

Camcorder

Operating Instructions

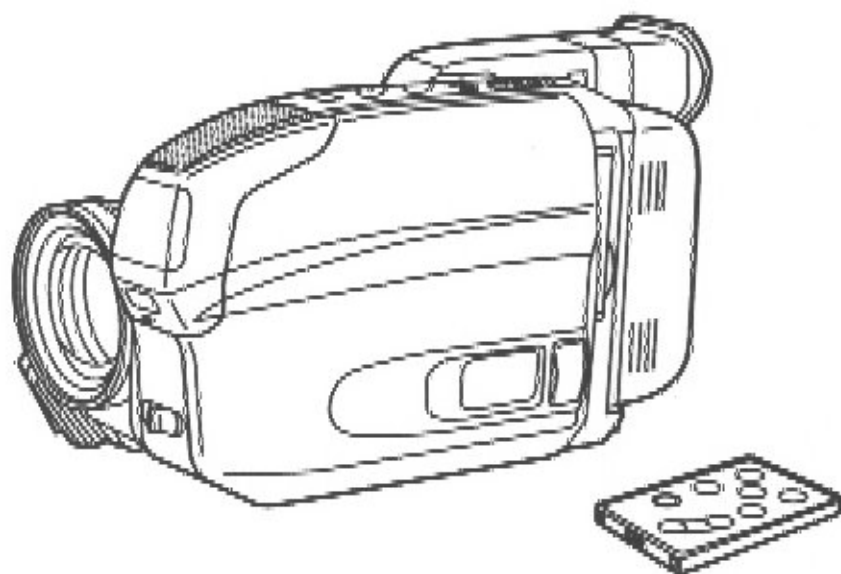

VHS

PV-D506

Before attempting to connect, operate or adjust this product, please read these instructions thoroughly.

Spanish Quick Use Guide is included.

Guía para rápida consulta en español está incluida.

VOTW0268 (W)

Things You Should Know

Thank you for choosing Panasonic!

You have purchased one of the most sophisticated and reliable products on the market today. Used properly, we're sure it will bring you and your family years of enjoyment. Please take time to fill in the information at right. The serial number is on the tag located on the underside of your Palmcorder. Be sure to **retain this manual** as your convenient Palmcorder information source.

Date of Purchase _____

Dealer Purchased From _____

Dealer Address _____

Dealer Phone No. _____

Model No. _____

Serial No. _____

Unpack your Palmcorder

These accessories are provided in order to set up or use your Palmcorder.

1 pc. AC Adaptor
(PV-A17)
with DC Power
Cable

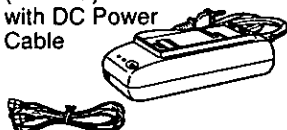

1 pc. Battery Pack
(PV-BP18)



1 pc. Audio/Video
Cable (VJAW0032)



1 pc. Shoulder Strap
(VYCW0108)



1 pc. VHS PlayPak
(PV-P1/VYMW0009)
and one "AA" battery

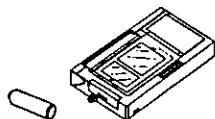

1 pc. 9-Function Remote
(VSQW0033) with one
CR2025 Battery



1 pc. CR2025 Clock
Battery (VSBW0004)
(installed in Palmcorder)



Remote has been loaded with battery and comes stored in Palmcorder. See page 23.

Safety Precautions

WARNING: TO PREVENT FIRE OR SHOCK HAZARD, DO NOT EXPOSE THIS EQUIPMENT TO RAIN OR MOISTURE.

Your Compact VHS Palmcorder is designed to record and play back in Standard Play (SP) and Super Long Play (SLP) modes. You can also play a Compact VHS Palmcorder recording on your VHS VCR using the VHS PlayPak supplied.

This Palmcorder is equipped with the HQ System to provide excellent video pictures, and is compatible with standard VHS equipment.

It is recommended that only cassette tapes that have been tested and inspected for use in VCR machines with the **VHS-C** and/or **VHS** mark be used.



CAUTION
RISK OF ELECTRIC SHOCK
DO NOT OPEN



**CAUTION: TO REDUCE THE RISK OF ELECTRIC SHOCK,
DO NOT REMOVE COVER (OR BACK)
NO USER-SERVICABLE PARTS INSIDE
REFER SERVICING TO QUALIFIED SERVICE PERSONNEL**



This symbol warns the user that uninsulated voltage within the unit may have sufficient magnitude to cause electric shock. Therefore, it is dangerous to make any kind of contact with any inside part of this unit.



This symbol alerts the user that important literature concerning the operation and maintenance of this unit has been included. Therefore, it should be read carefully in order to avoid any problems.

The above markings are located on the appliance bottom cover.

Important Safeguards

1. **Read Instructions** — All the safety and operating instructions should be read before the unit is operated.
2. **Retain Instructions** — The safety and operating instructions should be retained for future reference.
3. **Heed Warnings** — All warnings on the unit and in the operating instructions should be adhered to.
4. **Follow Instructions** — All operating and maintenance instructions should be followed.
5. **Cleaning** — Unplug this video unit from the wall outlet before cleaning. Do not use liquid or aerosol cleaners. Use a dry cloth for cleaning.
6. **Attachments** — Do not use attachments not recommended by the video product manufacturer as they may be hazardous.
7. **Water and Moisture** — Do not use this video unit near water — for example near a bath tub, wash bowl, kitchen sink, or laundry tub, in a wet basement, or near a swimming pool, and the like.
8. **Accessories** — Do not place this video unit on an unstable cart, stand, tripod, bracket, or table. The video unit may fall, causing serious injury to a child or adult, and serious damage to the unit. Use only with a cart, stand, tripod, bracket, or table recommended by the manufacturer, or sold with the video unit. Any mounting of the unit should follow the manufacturer's instructions and should use a mounting accessory recommended by the manufacturer. An appliance and cart combination should be moved with care. Quick stops, excessive force, and uneven surfaces may cause the appliance and cart combination to overturn.
9. **Ventilation** — Slots and openings in the cabinet are provided for ventilation and to ensure reliable operation of the video unit and to protect it from overheating. These openings must not be blocked or covered. Never place the video unit on a bed, sofa, rug, or other similar surface, or near or over a radiator or heat register. This video unit should not be placed in a built-in installation such as a bookcase or rack unless proper ventilation is provided or the manufacturer's instructions have been adhered to.
10. **Power Sources** — This video unit should be operated only from the type of power source indicated on the marking label. If you are not sure of the type of power supply to your home, consult your appliance dealer or local power company. For video units intended to be operated from battery power, or other sources, refer to the operating instructions.



11. **Grounding or Polarization** — This video unit may be equipped with either a polarized 2-wire AC (Alternating Current) line plug (a plug having one blade wider than the other) or 3-wire grounding type plug, a plug having a third (grounding) pin. The 2-wire polarized plug will fit into the power outlet only one way. This is a safety feature. If you are unable to insert the plug fully into the outlet, try reversing the plug. If the plug still fails to fit, contact your electrician to replace your obsolete outlet. Do not defeat the safety purpose of the polarized plug.
The 3-wire grounding type plug will fit into a grounding type power outlet. This is a safety feature. If you are unable to insert the plug into the outlet, contact your electrician to replace your obsolete outlet. Do not defeat the safety purpose of the grounding type plug.
12. **Power-Cord Protection** — Power-supply cords should be routed so that they are not likely to be walked on or pinched by items placed upon or against them, paying particular attention to cords of plugs, convenience receptacles, and the point where they exit from the unit.
13. **Outdoor Antenna Grounding** — If an outside antenna or cable system is connected to the video unit, be sure the antenna or cable system is grounded so as to provide some protection against voltage surges and built-up static charges. Part 1 of the Canadian Electrical Code, in USA Section 810 of the National Electrical Code, provides information with respect to proper grounding of the mast and supporting structure, grounding of the lead-in wire to an antenna discharge unit, size of grounding conductors, location of antenna discharge unit, connection to grounding electrodes, and requirements for the grounding electrode.

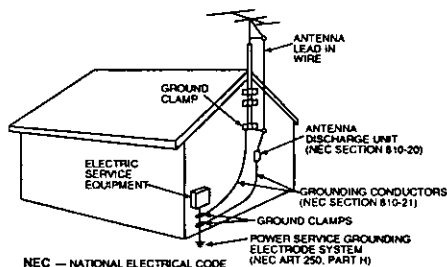

14. **Lightning** — For added protection of this video unit receiver during a lightning storm, or when it is left unattended and unused for long periods of time, unplug it from the wall outlet and disconnect the antenna or cable system. This will prevent damage to the video unit due to lightning and power-line surges.

Important Safeguards

15. **Power Lines** — An outside antenna system should not be located in the vicinity of overhead power lines or other electric light or power circuits, or where it can fall into such power lines or circuits. When installing an outside antenna system, extreme care should be taken to keep from touching such power lines or circuits as contact with them might be fatal.
16. **Overloading** — Do not overload wall outlets and extension cords as this can result in a risk of fire or electric shock.
17. **Objects and Liquids** — Never push objects of any kind into this video unit through openings as they may touch dangerous voltage points or short out parts that could result in a fire or electric shock. Never spill liquid of any kind onto the video unit.
18. **Servicing** — Do not attempt to service this video unit yourself as opening or removing covers may expose you to dangerous voltage or other hazards. Refer all servicing to qualified service personnel.
19. **Damage Requiring Service** — Unplug this video unit from the wall outlet and refer servicing to qualified service personnel under the following conditions:
 - a. When the power-supply cord or plug is damaged.
 - b. If any liquid has been spilled onto, or objects have fallen into the video unit.
 - c. If the video unit has been exposed to rain or water.
 - d. If the video unit does not operate normally by following the operating instructions. Adjust only those controls that are covered by the operating instructions, as an improper adjustment of other controls may result in damage and will often require extensive work by a qualified technician to restore the video unit to its normal operation.
 - e. If the video unit has been dropped or the cabinet has been damaged.
 - f. When the video unit exhibits a distinct change in performance — this indicates a need for service.
20. **Replacement Parts** — When replacement parts are required, be sure the service technician has used replacement parts specified by the manufacturer or have the same characteristics as the original part. Unauthorized substitutions may result in fire, electric shock or other hazards.
21. **Safety Check**— Upon completion of any service or repairs to this video unit, ask the service technician to perform safety checks to determine that the video unit is in safe operating order.

Precautions

USE & LOCATION

- **TO AVOID SHOCK HAZARD ...** Your Camcorder and power supply should not be exposed to rain or moisture. Do not connect the power supply or operate your Camcorder if it gets wet. Your Camcorder has been designed for outdoor use, however it is not designed to sustain direct exposure to water, rain, sleet, snow, sand, dust, or to direct splashing from a pool or even a cup of coffee. This action could permanently damage the internal parts of your Camcorder. Do not attempt to disassemble this unit. There are no user serviceable parts inside. Unplug your Camcorder from the power supply before cleaning.
- **DO NOT AIM YOUR CAMCORDER AT THE SUN OR OTHER BRIGHT OBJECTS**
- **DO NOT LEAVE THE PALMCORDER WITH THE EVF AIMED DIRECTLY AT THE SUN AS THIS MAY CAUSE DAMAGE TO THE INTERNAL PARTS OF THE EVF**
- **DO NOT EXPOSE YOUR CAMCORDER TO EXTENDED HIGH TEMPERATURE ...** Such as, in direct sunlight, inside a closed car, next to a heater, etc... This action could permanently damage the internal parts of your Camcorder.
- **AVOID SUDDEN CHANGES IN TEMPERATURE ...** If the unit is suddenly moved from a cold place to a warm place, moisture may form on the tape and inside the unit.
- **DO NOT LEAVE YOUR CAMCORDER OR THE POWER SUPPLY TURNED ON WHEN NOT IN USE.**
- **STORAGE OF YOUR CAMCORDER ...** Store and handle your Camcorder in a manner that will not subject it to unnecessary movement (avoid shaking and striking). Your Camcorder contains a sensitive pick-up device which could be damaged by improper handling or storage.

CARE

- **TO CLEAN YOUR CAMCORDER ...** Do not use strong or abrasive detergents when cleaning your Camcorder body.
- **TO PROTECT THE LENS ...** Do not touch the surface of the lens with your hand. Use a commercial camcorder lens solution and lens paper when cleaning the lens. Improper cleaning can scratch the lens coating.
- **TO PROTECT THE FINISH OF YOUR CAMCORDER ...** Before handling your Camcorder, make sure your hands and face are free from any chemical products, such as suntan lotion, as it may damage the finish.

Table of Contents

Getting Started

Things You Should Know	2
Important Safeguards	3, 4
Precautions	4
Quick Operation Guide	6
Supplying Power	
Charge the Battery Pack	7
Use the Battery Pack	7
Battery Refresh Feature	8
Battery Care	8
AC Adaptor	9
Car Battery Cord (Optional)	9
Cassette Information	10
Setting the Clock	
Set the Time Zone	11
Set the Daylight Saving Time	12
Set the Date and Time	13
Replace the Battery	14
Electronic Viewfinder Indications	15, 16, 17
Built-in Auto Light	18
Attaching the Shoulder Strap	19

Basic Operation

Camera Recording	
Simple Recording	20
Stand-by Mode	21
Stand-by Release	21
Easy Edit Stand-by	22
Manual Easy Editing	22
9-Function Remote Control	23
Programmed Recording	24
Playback your Recordings	
Playback using the EVF	25
Playback using the PlayPak	26
Playback or View on a TV	27

Special Features

Four-Speed Power Zoom	28
High Speed Shutter	28
Focus	29
Backlight	30
One-Touch Auto Fade (BLACK or WHITE only)	30
Color Digital Fade (other than BLACK and WHITE)	31
Color Digital Filter	32
Digital Zoom	33
Digital Electronic Image Stabilization System	34
Still/Strobe/Wide	35
Digital Wipe	36
Motion Detection (MotionSensor)	37
Intelligent Titrer	38
Copying your Tapes (dubbing)	39

For Your Information

Palmcorder Accessory System	40
Notes Regarding Operations	41
Specifications	42
Before Requesting Service	43, 44
Index of Controls	45, 46, 47, 48, 49
Index	50
Spanish Quick Use Guide/Guía Para Uso Rápido	51, Back Cover

Quick Operation Guide

Camera Recording

Charge the Battery Pack fully before operation (see page 7).

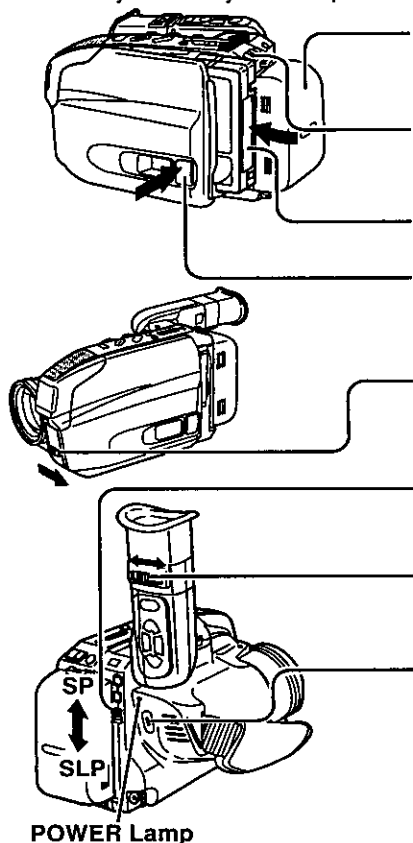
- 
- 1** Attach the Battery (see page 7).
Make sure Battery is charged before use (see page 7).
 - 2** Slide the TAPE EJECT switch to open the door.
 - 3** Insert a cassette (see page 10).
 - 4** Press here to close the door.
 - 5** Set the POWER switch to CAMERA.
Built-In Lens Cover opens and POWER Lamp lights.
 - 6** Slide the TAPE SPEED Selector for SP or SLP (see page 10).
 - 7** With the Eye Cup up to your eye, adjust the Vision Adjustment Control to your eyesight.
 - 8** Press RECORD/PAUSE to start recording.
Press RECORD/PAUSE again to pause recording (see page 20).
- POWER Lamp

To Watch Playback in the EVF (Electronic Viewfinder)

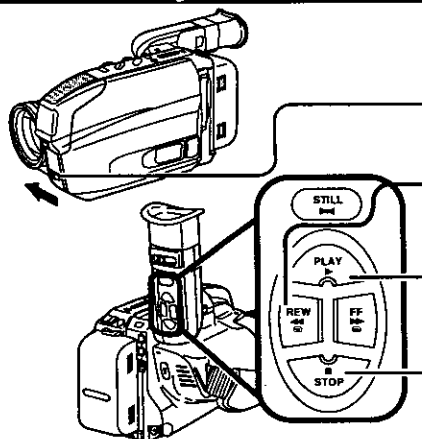
- 
- 1** Set the POWER switch to VCR.
 - 2** Press REWIND/SEARCH to rewind the tape.
 - 3** Press PLAY to start playback.
 - 4** Press STOP to stop playback.

Charge the Battery Pack

Charge the Battery Pack fully before operation.

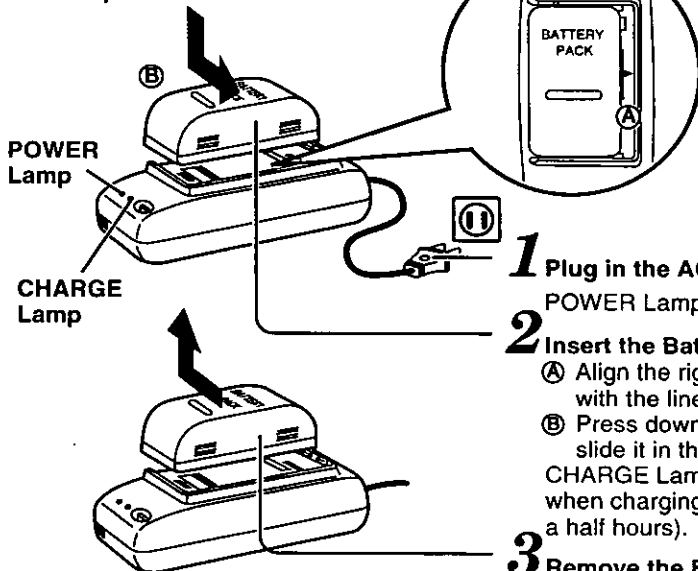

1 Plug in the AC Adaptor.
POWER Lamp lights up.

2 Insert the Battery
A Align the right side of the Battery with the line on the AC Adaptor.
B Press down on the Battery and then slide it in the direction of the arrow.
CHARGE Lamp lights up. It goes out when charging is done (about one and a half hours).

3 Remove the Battery
Slide the Battery out and then lift up.

Note:

After recharging the Battery Pack about 5 times, use the BATTERY REFRESH feature as explained on page 8.

- The useful operation time of the Battery will gradually decrease after repeated use and recharging. The Battery is no longer serviceable if the operation time is very short, even after a sufficient charge.

Use the Battery Pack

With a fully charged Battery Pack, you will have a maximum of about one and a half hours of continuous use. (If the Built-in Light is used, battery operating time decreases.)

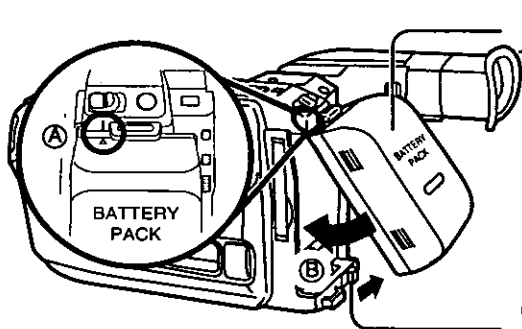

1 Attach the Battery
A Align the Battery with the top of the mounting surface.
B Press it into place until it locks with a click.

2 Remove the Battery
While sliding the BATTERY RELEASE button, remove the Battery.

Supplying Power

Battery Refresh Feature

This feature completely discharges the Battery before recharging begins. To maintain your battery's operating capacity, use the refresh feature after about every five charges.

CHARGE Lamp

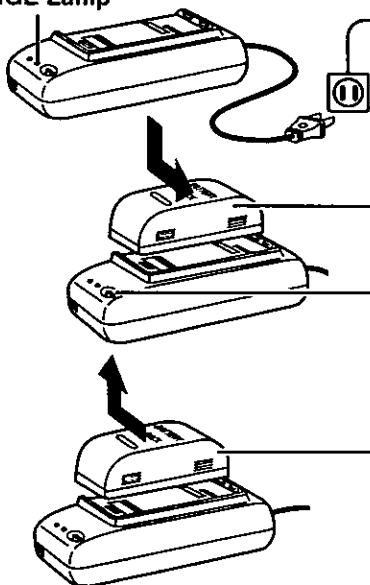

1 Plug in AC Adaptor.

2 Place the Battery into the AC Adaptor.

3 Press the **BATTERY REFRESH** button.
The **CHARGE** Lamp will flash when discharging begins and stop flashing when fully discharged. **POWER** Lamp will stay lit when fully charged.

4 Remove the Battery

- Should you accidentally press the **BATTERY REFRESH** button, remove Battery and then re-insert it to begin charging.
- It takes about seven and a half hours when both Battery Refresh and charging are performed.

ONLY FOR U.S.A.

ATTENTION:



The product that you have purchased is powered by a rechargeable battery. The battery is recyclable. At the end of its useful life, under various state and local laws, it may be illegal to dispose of this battery into the municipal waste stream. Check with your local solid waste officials for details in your area for recycling options or proper disposal.

Battery Care

Caution:

- Charge only with specified charger.
- The Battery can be charged within a temperature range of 32° F (0° C) and 104° F (40° C).
- The Battery may be warm after charging or just after use. This is normal.
- Do not use an insufficiently charged or worn out Battery.

Safety precautions:

- Do not get the Battery near, or dispose of in fire.
- Do not directly connect (short circuit) the positive (+) and negative (-) terminals.
- Never attempt to disassemble or reassemble the Battery.

To avoid damage to the Battery:

- Do not drop or jar the Battery.
- Use the Battery with specified units only.
- If the Battery is used in extremely high temperatures, a safety device will automatically prevent operation.

To insure longer battery life:

- While not in use, remove Battery from the Palmcorder and AC Adaptor and store in a cool, dark, dry place.
- Keep the Battery terminals clean.

AC Adaptor

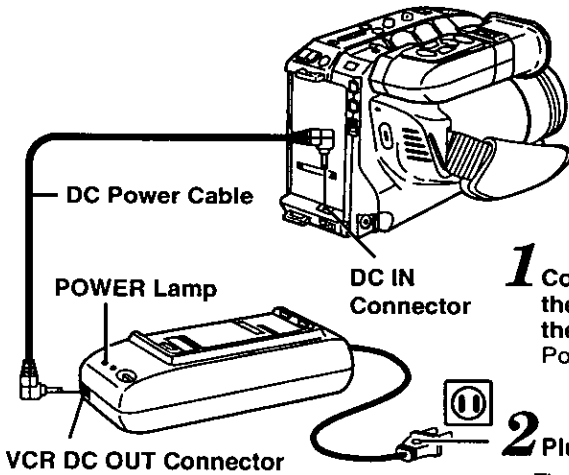

1 Connect the VCR DC OUT on the AC Adaptor to the DC IN on the Palmcorder with the DC Power Cable (supplied).

2 Plug in the AC Adaptor.

- The POWER Lamp will light up.

Note:

- AC Adaptor can not be used to power the Palmcorder while charging the Battery.
- While not in use, unplug the AC Adaptor from the AC outlet. (AC Adaptor consumes 1.2W of electric power if it is plugged into an AC outlet even when not in use.)

Car Battery Cord (Optional)

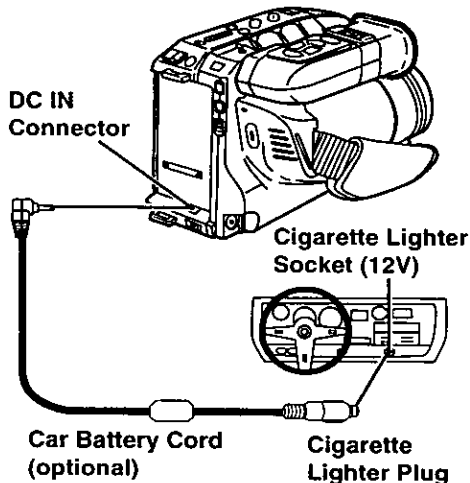

1 Connect a PV-C16 Car Battery Cord (optional) to the DC IN of the Palmcorder.

2 Start your car engine and then insert the Car Battery Cord plug into your cigarette lighter socket.

- There is a fuse located in the lighter plug end of the cord.
Should fuse replacement be necessary use the exact current rating (in amps).

Note:

- This cord can only be used in vehicles equipped with DC 12V (negative ground) batteries. Use only the specified car battery cord. If you are not sure check with your local car/truck dealer as to what type of DC battery ground you have in your vehicle.
- Be sure to start your car engine before inserting the cigarette lighter plug of the Car Battery Cord into the lighter socket; otherwise, the cigarette lighter plug fuse may burn out.
- Because the car is running while your Palmcorder is in operation, make sure you're in a well ventilated area.
- Disconnect the cigarette lighter plug when your Palmcorder is not being used.

Cassette Information

Cassette Insertion/Removal

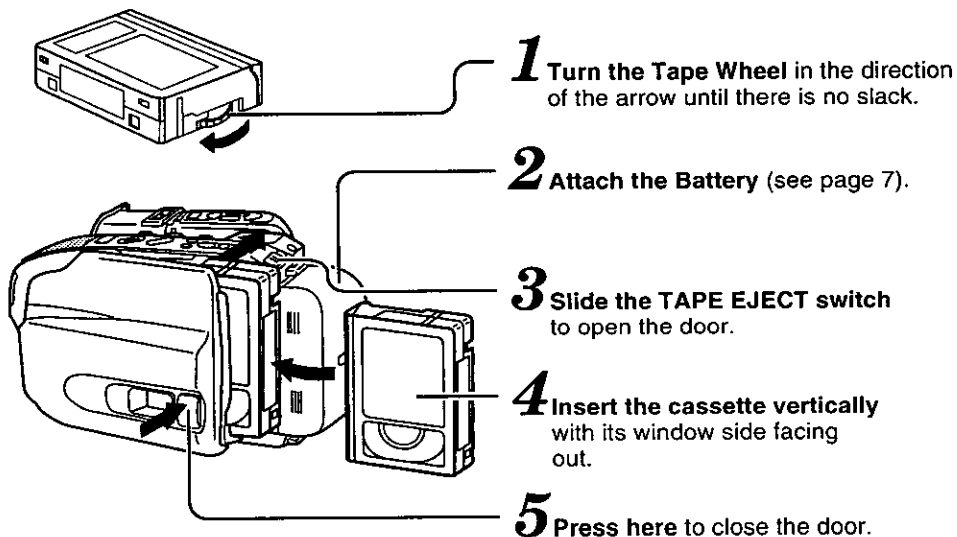

- To remove the cassette, slide the TAPE EJECT switch.

Record/Playback Time

Use tapes with the **VHSC** mark in this unit.

Tape Speed Selector Position	Cassette type		
	T-20	T-30	T-40
SP (Standard Play)	20 minutes	30 minutes	40 minutes
SLP (Super Long Play)	1 hour	1 hour 30 minutes	2 hours

- SP provides the best picture.
- SLP has slightly more picture noise during playback.

TAPE SPEED Selector

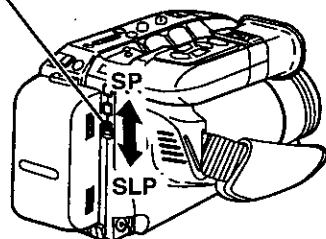

Erase Protection Tab

Cassettes have a record tab to ensure that recordings are not accidentally erased.

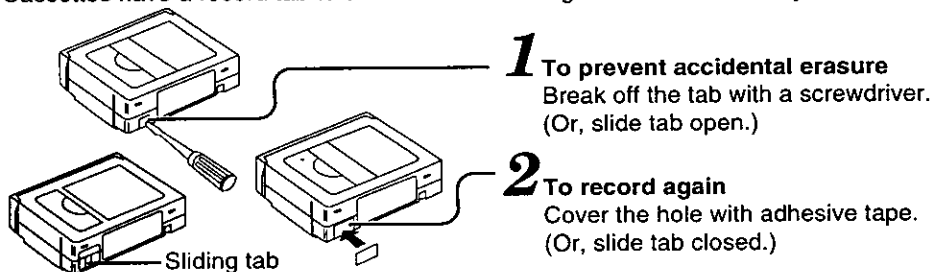

Setting the Clock

Setting the clock is divided into three sections; Set the Time Zone, Set the Daylight Saving Time, and Set the Date and Time. Please follow instructions in the order presented.

Set the Time Zone

The Palmcorder is set to the Eastern Standard time zone at the factory. If you live in a different time zone, follow the steps below to change it. Then, when traveling, rather than resetting the clock to the local time, you can simply set the appropriate time zone.

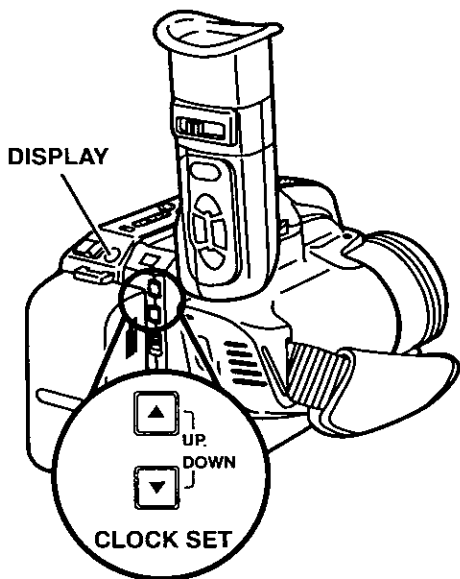

Time Zone chart

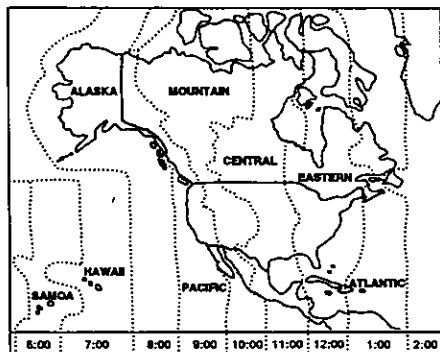

Before you begin...

- Connect the Palmcorder to a power source.
- Set the POWER switch to VCR or CAMERA.

Note:

CLOCK SET menu disappears if, after activation, CLOCK SET UP ▲, DOWN ▼ or DISPLAY buttons are not pressed within 30 seconds.

The Palmcorder's clock may lose or gain up to two minutes per month. Please adjust as necessary (refer to page 13).

1 Press **CLOCK SET UP ▲** to display the **CLOCK SET** menu.

2 Press **UP ▲** or **DOWN ▼** repeatedly to select **1.SELECT TIME ZONE** from the **CLOCK SET** menu.

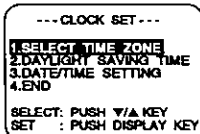

3 Press **DISPLAY** to display the **SELECT TIME ZONE** menu.

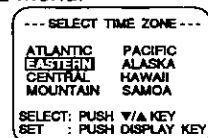

4 Press **UP ▲** or **DOWN ▼** repeatedly to select one of the eight time zones of the location where you are using the Palmcorder.

5 Press **DISPLAY** to fix the Time Zone. The **CLOCK SET** menu appears.

To exit from the **CLOCK SET** menu, select **4.END** and press **DISPLAY**.

Note:

When you travel outside the eight time zones right, please set the clock manually (see page 13).

Setting the Clock

Set the Daylight Saving Time

The clock will automatically adjust to daylight saving time.

Daylight Saving Time is preset to **AUTO**. If you do not want the clock to automatically adjust to daylight saving time, please select **OFF** by following steps 1-5 below.

Before you begin...

- Connect the Palmcorder to a power source.
- Set the POWER switch to VCR or CAMERA.

Note:

CLOCK SET menu disappears if, after activation, CLOCK SET UP ▲, DOWN ▼ or DISPLAY buttons are not pressed within 30 seconds.

This feature will not function if Hawaii or Samoa Time Zone is selected.

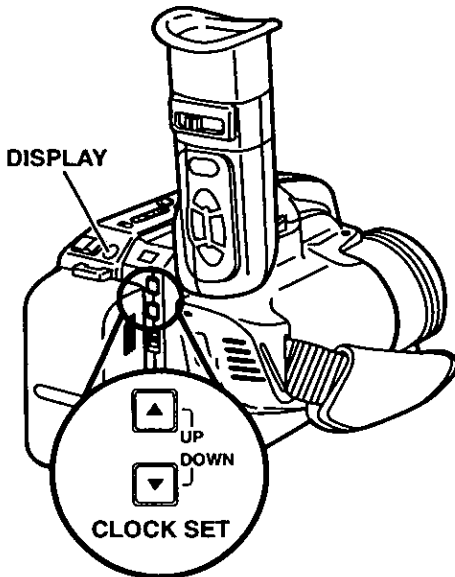

- 1** Press **CLOCK SET UP ▲** to display the **CLOCK SET** menu.
- 2** Press **UP ▲** or **DOWN ▼** repeatedly to select **2.DAYLIGHT SAVING TIME** from the **CLOCK SET** menu.

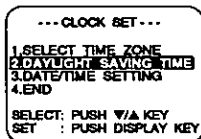

- 3** Press **DISPLAY** to display the **DAYLIGHT SAVING TIME** menu.



Spring:

First Sunday in April (DAYLIGHT SAVING TIME: AUTO) Automatically adds one hour and adjusts the clock.

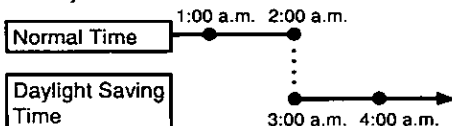

Autumn:

Last Sunday in October (DAYLIGHT SAVING TIME: AUTO) Automatically turns back one hour and adjusts the clock.

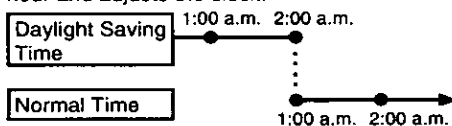

- 4** Press **UP ▲** or **DOWN ▼** to select **AUTO** or **OFF**.

- 5** Press **DISPLAY** to fix the **DAYLIGHT SAVING TIME** setting. The **CLOCK SET** menu appears.

To exit from the **CLOCK SET** menu, select **4.END** and press **DISPLAY**.

Setting the Clock

Set the Date and Time

The date and time is calculated, including leap year, up to DEC 31 2094.

Before you begin...

- Connect the Palmcorder to a power source.
- Set the POWER switch to VCR or CAMERA.

Note:

CLOCK SET menu disappears if, after activation, CLOCK SET UP ▲, DOWN ▼ or DISPLAY buttons are not pressed within 30 seconds.

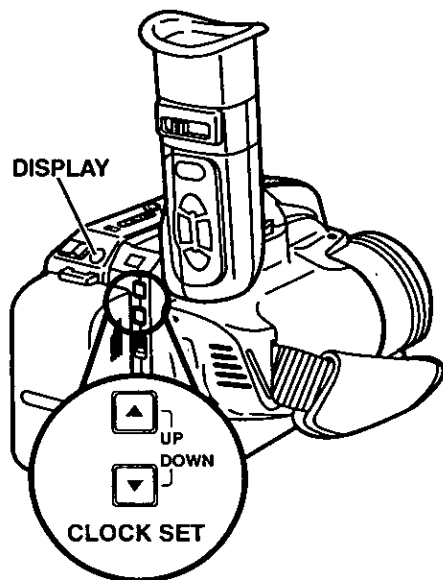

1 Press **CLOCK SET UP ▲** to display the **CLOCK SET** menu.

2 Press **UP ▲** or **DOWN ▼** repeatedly to select **3.DATE/TIME SETTING** from the **CLOCK SET** menu.

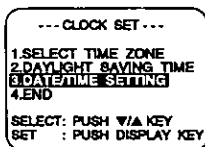

3 Press **DISPLAY** to display the **DATE/TIME SETTING** menu.

4 Press **UP ▲** or **DOWN ▼** repeatedly (or hold down) to enter the desired numbers, then, press **DISPLAY** to fix that portion and move to the next.

Adjust the flashing digits for the hour, minute, month, day and year.

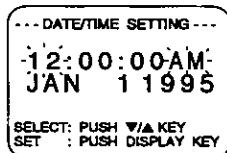
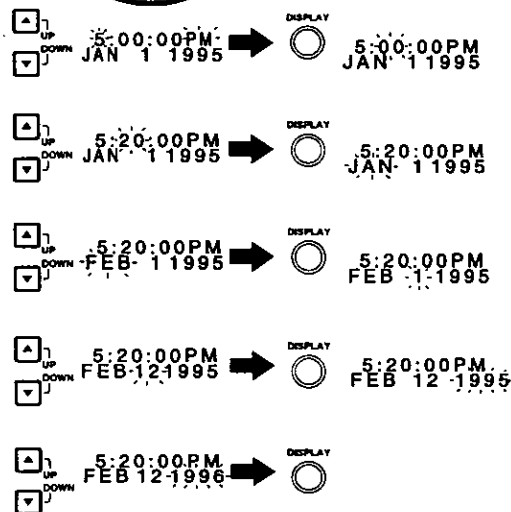

When you finish setting the year, the clock starts operating, and the **CLOCK SET** menu appears.

To exit from the **CLOCK SET** menu, select **4.END** and press **DISPLAY**.

Setting the Clock

Replace the Battery

The date and time operates on a miniature battery preinstalled in the underside of your Palmcorder.

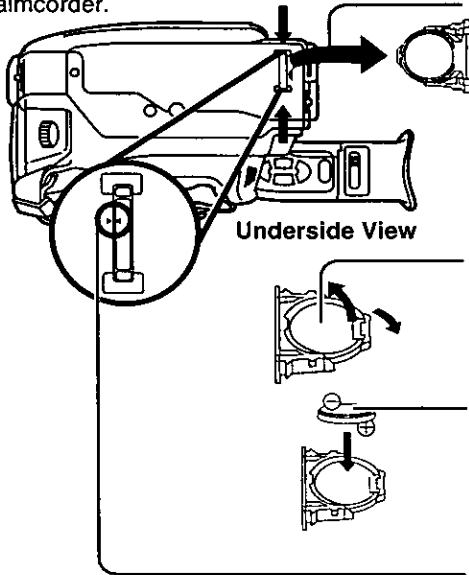

1 While pinching the stopper tabs, pull the tray out of the Battery Compartment.

2 Remove the Battery by bending the locking tab outward.

3 Place the new Battery into the Battery tray with the ⊕ mark facing down until it snaps into place.

- Do not reverse the polarity.

4 Replace the Battery tray so that the small triangle marks meet.

Replace battery with Panasonic PART NO. VSBW0004 (CR2025) only. Use of another battery may present a risk of fire or explosion. Caution-battery may explode if mistreated. Dispose of used battery promptly. Keep away from children. Do not recharge, disassemble or dispose of in fire.

Note:

- Make sure your Palmcorder is off when replacing the Battery.
- Keep the Battery out of the reach of children since swallowing it may be harmful.
- When the Battery is installed improperly, is discharged, or missing, "CLOCK BATTERY" appears in the EVF.
- Battery life is approximately 5 years.

Electronic Viewfinder Indications

Tape/Battery Remaining

The tape remaining and battery charge level can be displayed during recording.

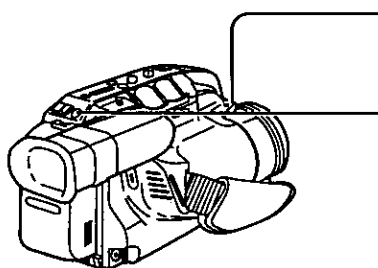

- 1 Set the POWER switch to CAMERA.
- 2 Press DISPLAY repeatedly to select the desired display.

EVF Indications

Battery Charge Remaining:

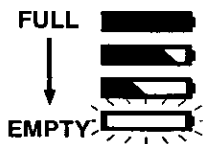

Tape Remaining:

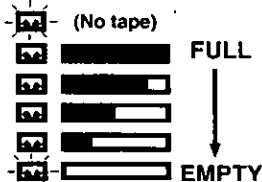

- It will take several seconds for the tape remaining indicator to operate after the tape starts moving.

Record the Date and Time

- 1 Set the POWER switch to CAMERA. When placed in Record mode, the time and date will be recorded on the tape.

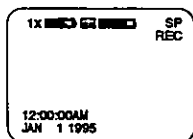

Note:

Only the Date and/or Time are recorded on the Tape.

Display-Off Mode

This feature allows you to remove all Electronic Viewfinder Indications.

Before inserting a tape, press DISPLAY and STOP together for more than one second to remove the indications except time and date*.

To display the Electronic Viewfinder Indications again, turn the Palmcorder Power off and then on again.

* To remove the time and date, see "Record the Date and Time" above.

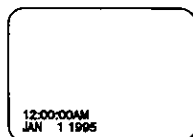
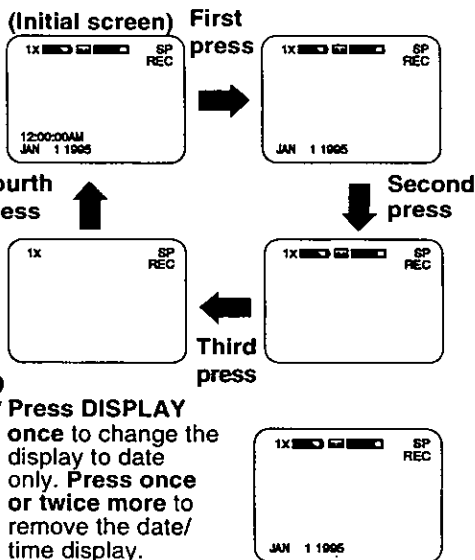

Electronic Viewfinder Indications

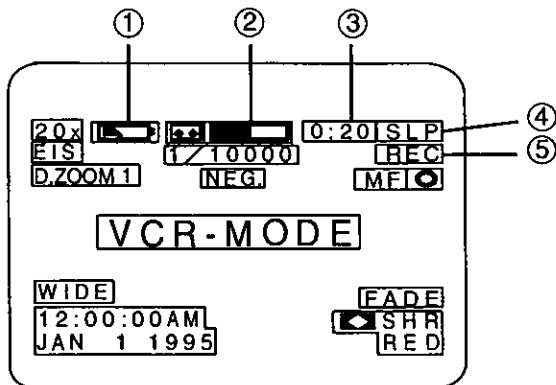

① Battery Remaining Indication (see page 15)

 When a battery recharge is necessary, "WARNING" will begin to flash in the EVF and "LOW BATTERY" will appear as the Power Lamp will also flash. The Palmcorder will automatically turn OFF in 15 seconds.

② Tape Remaining Indication

- If the Palmcorder is in camera mode with no cassette tape inserted or the record tab is missing, "⏏" will flash for one minute and "CHECK TAPE" will appear for 5 seconds, and recording will not start.
- While recording, as the tape reaches to the end, "TAPE END" will appear for 5 seconds as a warning.

③ 10-Second Reminder

An elapsed time indicator appears for one second every 10 seconds that recording continues.

This is a reminder of how long you have been shooting a particular scene and can help keep your recordings fresh and interesting.

0:00 0:10 0:20 59:50



(return to 0:00 and continue)

- The 10-Second Reminder will be reset whenever you press Record/Pause.

④ TAPE SPEED Indication (see page 10)

Indicates the tape speed (SP or SLP).

⑤ Operating Mode Indications

REC (record)

(RECORD will first appear in large characters for one second and then small characters.)

PAUSE

(PAUSE will first appear in large characters for one second and then small characters.)

FF (fast forward)

PLAY

REW (rewind)

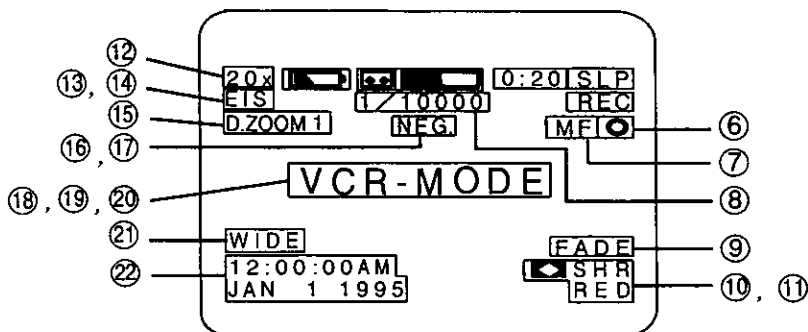

- ⑥ Backlight Indication (see page 30).
- ⑦ Manual Focus Indication (see page 29).
- ⑧ High Speed Shutter Indication (see page 28).
- ⑨ Fade Indication (see page 30).
- ⑩ Color Digital Fade Indication (see page 31).
- ⑪ Color Digital Filter Indication (see page 32).
- ⑫ Zoom Magnification level (see page 28).
- ⑬ Digital E.I.S. Indication (see page 34).
- ⑭ Digital Wipe Indication (see page 36).
- ⑮ Digital Zoom Indication (see page 33).
- ⑯ Negative/Positive Indication (see page 32).
- ⑰ Still/Strobe Indication (see page 35).

⑱ VCR-MODE Indication

"VCR-MODE" will appear for one minute if the POWER switch is set to VCR or the RECORD/PAUSE button is pushed in VCR MODE.

⑲ DEW Indication

If excessive moisture condenses in the unit, "WARNING" and Power Lamp will flash, "DEW DETECTED" will appear, and the Palmcorder will automatically turn OFF in 15 seconds.

In this case, wait until the indicator no longer flashes when your Palmcorder is turned on before using your Palmcorder again.

⑳ Motion Detection (MotionSensor) Indication (see page 37).

㉑ Wide Screen Indication (see page 35).

㉒ Date and Time Indication (see page 13).

Built-in Auto Light

Using the Built-in Auto Light

To improve recording indoors or outdoors in dim lighting conditions.

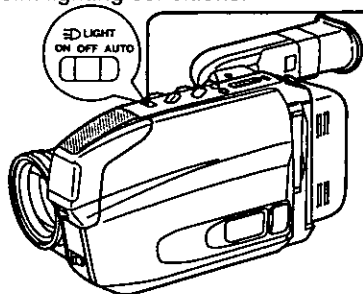

Before you begin...

- Connect the Palmcorder to a power source.
- Set the POWER switch to CAMERA.

Set LIGHT to AUTO.

The Palmcorder's built-in Light automatically turns on in dim lighting conditions. When lighting conditions reach over 2000 lx, the light turns off. Please be sure LIGHT is OFF when not in use or before placing Palmcorder into an optional carrying case.

Set LIGHT to ON/OFF to turn the light on and off manually.

Caution:

This light becomes hot during operation. Make sure nothing covers the Light during operation.

Before you begin...

- Set the POWER switch to OFF.

Replacing the Bulb

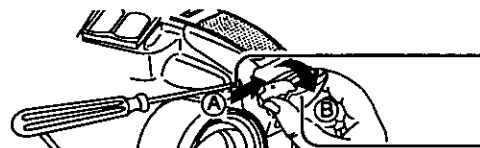

1 Turn screw counterclockwise and remove.

2 Ⓐ Slide the Built-in Light unit to right to unlock Ⓑ and remove it from the Palmcorder.

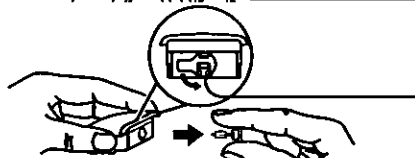

3 Turn the Bulb Housing counterclockwise 1/4 of a turn and pull free from the Built-in Light unit.

Built-in Light Unit Bulb Housing

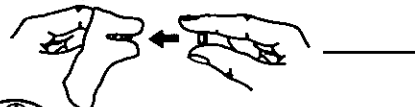

4 Using a clean cloth or tissue, replace the bulb.



5 Ⓐ Replace the Bulb Housing turning it clockwise. Ⓑ Then replace the Built-in Light Unit and slide it to left to lock. Ⓒ Finally, replace the screw.

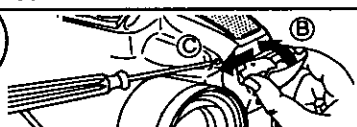

DANGER:

When replacing the bulb, use only lamp bulbs (PART NO. VLLW0007) supplied by Panasonic to reduce the risk of fire.

Use a cloth or tissue when handling the bulb as finger oils will decrease the bulb life.

To prevent possible burn hazard, disconnect the Built-in Light and allow the lamp to cool before replacing.

Note:

- Using the light reduces battery operating time.
- If using the Built-in Light in a hot environment for an extended period of time, be sure to provide ventilation.
- Using the Built-in Light when the Palmcorder is powered by a car battery may shorten bulb life.

Attaching the Shoulder Strap

Make sure the Battery Pack is not attached.

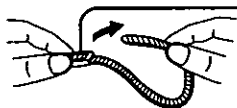

1 Unthread the strap from the buckle.

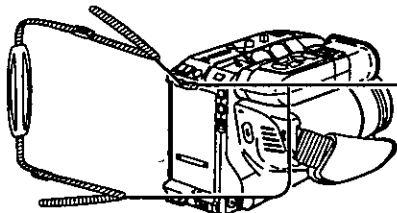

2 Thread the strap ends through the Strap Attachment Rings.



min. 1 inch

3 Then thread the ends of the strap through the buckle.
• Make sure the strap is not twisted.

Adjust the Length

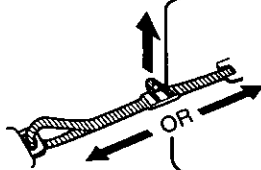

1 Pull a loop of the strap loose from the buckle.

2 Pull the strap firmly through the buckle to adjust the length.

Hand Strap

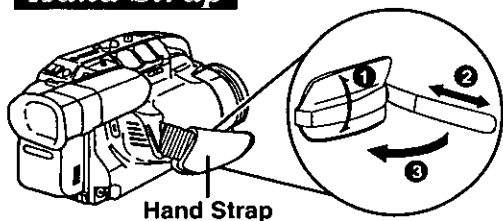

Hand Strap

Adjust the length of the strap to the size of your hand as illustrated at left.

Camera Recording

Simple Recording

Before you begin...

- Connect the Palmcorder to a power source.
- Insert a cassette with record tab (see page 10).

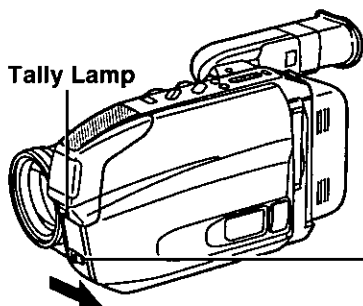

- 1** Set the POWER switch to CAMERA. Built-In Lens Cover opens.

EVF

PAUSE

Record/Pause mode.

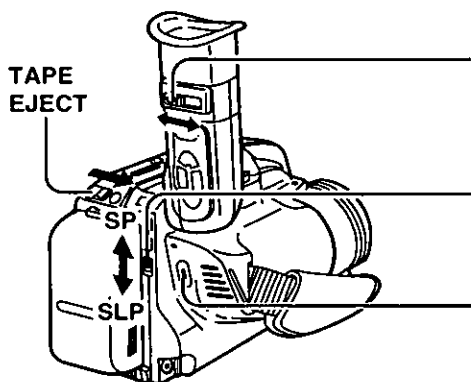

- 2** With the Viewfinder Eye Cup up to your eye, adjust the Vision Adjustment Control to your eyesight.

- 3** Slide the TAPE SPEED Selector to SP or SLP (refer to page 10).

- 4** Press RECORD/PAUSE to start recording. The Tally Lamp and RECORD/PAUSE are lit during recording.

Note:

- Do not leave the Palmcorder with the EVF aimed directly at the sun as this may cause damage to the internal parts of the EVF.

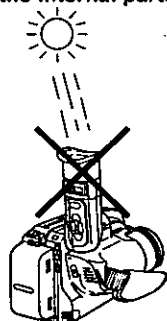

- When your Palmcorder is aimed at excessively bright objects, or bright lights, a vertical bar may appear in the picture. This is a normal characteristic of the CCD pick-up device. Try to avoid this when possible.



Press RECORD/PAUSE again to pause recording.

Set the Power switch to OFF after recording is finished.

- To remove the cassette In Record/Pause mode, slide the TAPE EJECT switch (refer to page 10).

Stand-by Mode

Whenever the Palmcorder has been in Record/Pause mode for 5 minutes, it will automatically go into Stand-by mode to conserve power. To resume recording, it is necessary to turn the Palmcorder POWER switch to OFF and then to CAMERA. Or, you may use the following feature to avoid having to turn the Palmcorder off and on again.

Stand-by Release

This feature allows you to resume recording from Stand-by mode by simply pressing the RECORD/PAUSE button.

Before you begin...

- Connect the Palmcorder to a power source.
- Insert a cassette with record tab (see page 10).

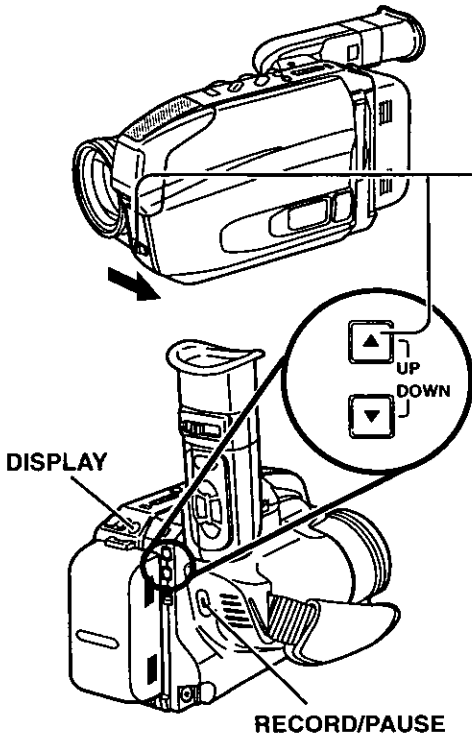

1 While pressing the UP ▲ button, set the POWER switch to CAMERA.

2 Press UP ▲ more than 2 seconds to display the STAND-BY RELEASE selection screen.

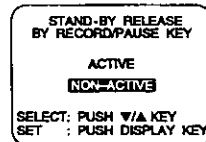

3 Press UP ▲ or DOWN ▼ as necessary to select **ACTIVE**.

4 Press DISPLAY to set your selection and exit this screen.

- You may now turn the Palmcorder back on after it has gone into Stand-by mode by pressing the RECORD/PAUSE button.

Note:

If **NON-ACTIVE** was selected in step 3 above, you must set the POWER switch to OFF and then to CAMERA to resume recording from Stand-by mode.

Camera Recording

Easy Edit Stand-by

If you stop recording but plan to resume within 24 hours, use the Edit Standby feature to make a smooth transition between scenes.

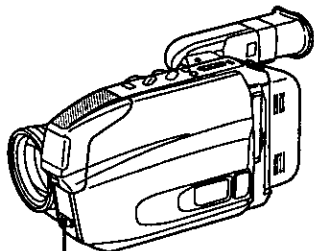

POWER Switch

Set the **POWER** switch to **OFF** and leave the cassette in the Palmcorder.

Set the **POWER** switch to **CAMERA** and press **RECORD/PAUSE** (within 24 hours) to continue recording.

Note:

- If it is going to be longer than 24 hours before you resume recording, use the manual Easy Edit feature described below.

Manual Easy Editing

For proper continuity when taping from the Stop mode, or after changing the Battery Pack.

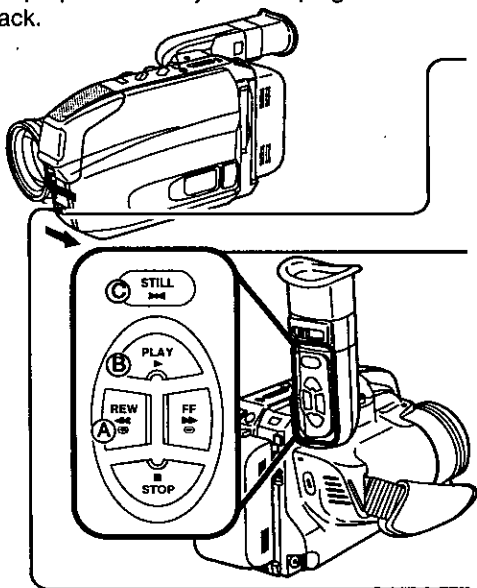

1 Set the **POWER** switch to **VCR**.

- 2**
- A** Press **REWIND/SEARCH** to go back a few seconds on the tape.
 - B** Press **PLAY** to review the picture on the Viewfinder.
 - C** Press **STILL** at the location you wish to continue your recording.

3 Set the **POWER** switch to **CAMERA**.

4 Press **RECORD/PAUSE** to continue recording.

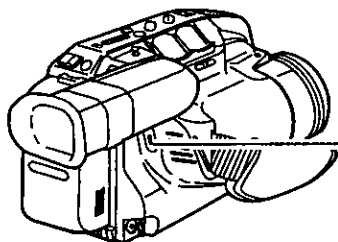

9-Function Remote Control

Removing and Storing the Remote

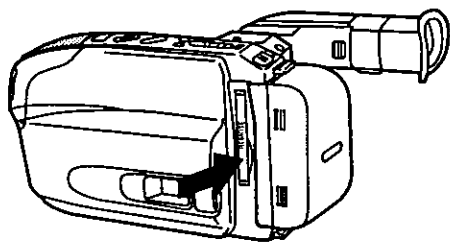

To remove,
press in on the Remote as shown by the arrow and it will release.

To store,
insert the Remote into the slot, the function buttons may face in either direction, press the remote control until it locks into place, as shown by the arrow.

Remote Control Operation

Operate the major functions of your Palmcorder from up to 16 feet (5 m) (approx.) away. Aim the Remote Control at the Remote Sensor of the Palmcorder and press the desired buttons.

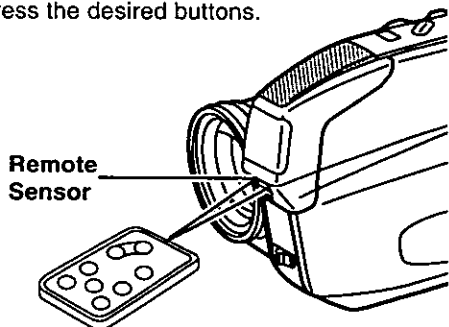

Controlled Functions

- Rec/Pause (see page 20)
- T (telephoto) Zoom
- W (wide angle) Zoom
- Play (see page 25)
- Fast Forward/Search (see page 25)
- Rewind/Search (see page 25)
- Stop (see page 25)
- Still (see page 25)
- Programmed Recording (see page 24)

Important Note:

- After 5 minutes in the Rec/Pause mode, the Palmcorder will shut off to conserve battery life. If within 30 minutes, press REC/PAUSE down for about one second, the Palmcorder comes back on and goes into the Record mode. If it is longer than 30 minutes before you resume recording, set the POWER switch to OFF and then to CAMERA.

Replace the Battery

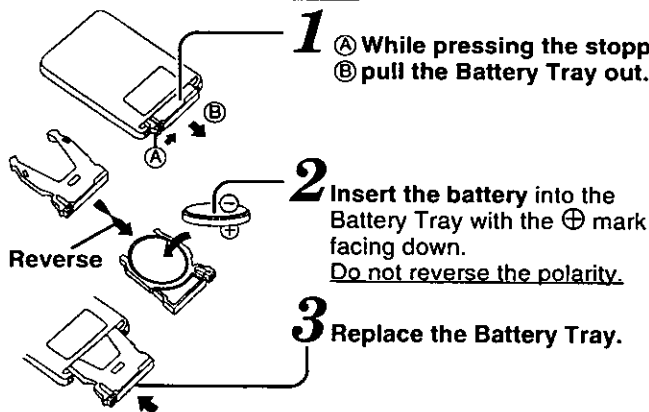

Replace battery with Panasonic PART NO. VSBW0004 (CR2025) only. Use of another battery may present a risk of fire or explosion. Caution-battery may explode if mistreated. Dispose of used battery promptly. Keep away from children. Do not recharge, disassemble or dispose of in fire.

Programmed Recording

Programmed Recording

You can program when to start and stop the recording just like the Stand-by OTR on a VCR deck. This is very convenient when you record something like a blooming flower while you are out. You can also use an interval recording. Two recording lengths, 5-second per minute or 10-second per minute, are available.

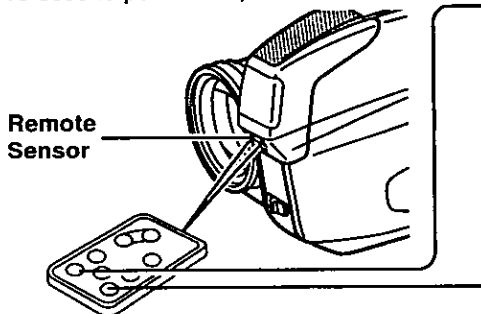

Before you begin...

- Connect the Palmcorder to a power source. For extended periods of recording, it is recommended to use the AC Adaptor for a power source.
- Insert a cassette with record tab (see page 10).
- Set the POWER switch to CAMERA.

- 1** Aim the Remote Control at the Remote Sensor and press **STANDBY** on the Remote repeatedly until the desired time to start will appear. Start time will increase 30 minutes.

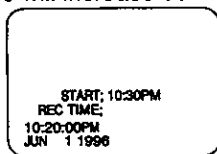

- 2** Press **OTR** on the Remote repeatedly to select desired recording length.

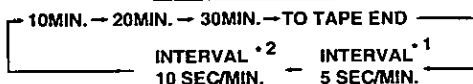
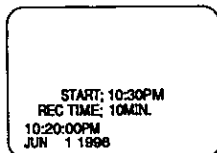

*1 5-second recording will be made each minute.

*2 10-second recording will be made each minute.

- 3** After setting, press **REC/PAUSE** on the Remote to go into stand-by mode.

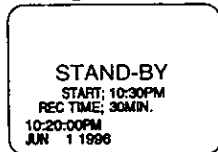

The Palmcorder will start recording at the desired timing. When the recording finishes, the Palmcorder will turn off automatically.

Note:

- Palmcorder will automatically turn off after 12 hours from recording start time or at tape end.
- Set the POWER switch to OFF to cancel the Programmed Recording feature.

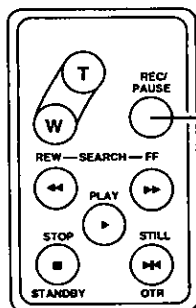

Playback your Recordings

Playback using the EVF

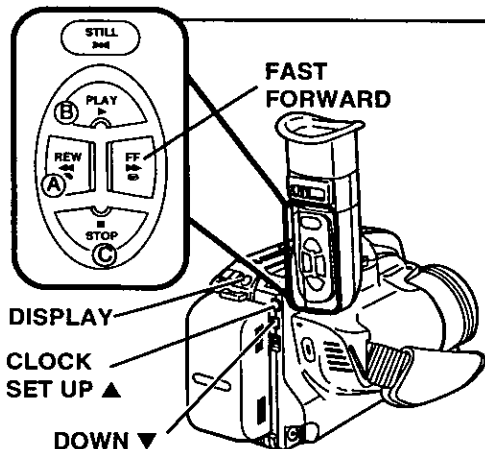
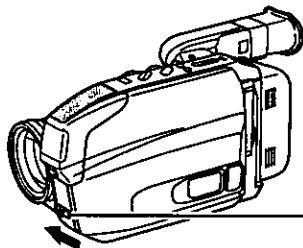

Before you begin...

- Connect the Palmcorder to a power source.
- Insert a recorded cassette.

1 Set the POWER switch to VCR.

- 2**
- Ⓐ Press REWIND/SEARCH to rewind the tape.
 - Ⓑ Press PLAY to start playback.
 - Ⓒ Press STOP to stop playback.

Auto Play

When the POWER switch is set to VCR, the cassette will automatically begin playback if the record tab has been removed.

Helpful Note:

Search Speed

Standard Play (SP) Search is about 3 times the normal speed, and Super Long Play (SLP) Search is about 9 times the normal speed.

Tracking Control

Auto Tracking

Continuously analyzes the signal of each recording for optimum picture quality.

Manual Tracking

To minimize the noise in some recordings, manual tracking may be necessary.

For Noise in Playback mode:

Press CLOCK SET UP ▲ or DOWN ▼ until picture clears.

Press DISPLAY to return to Auto Tracking.

For Noise in Still mode:

Press CLOCK SET UP ▲ or DOWN ▼ until picture clears.

V-Lock Control (Reduces jitter in Still mode.)

Press DISPLAY and CLOCK SET UP ▲ or DOWN ▼ until picture is stable.

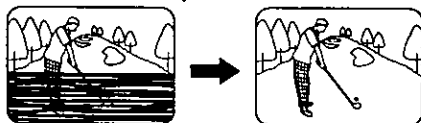

Special Effects Playback

(Sound is Muted)

Rapidly Locate a Scene

Press FAST FORWARD/SEARCH or REWIND/SEARCH for rapid visual search. Press again, or press PLAY, to resume normal speed.

View a Still Picture

Press STILL to freeze the playback picture. Press again to resume normal playback.

Note:

- During search playback, horizontal noise bars will appear and there will be no audio.
- To protect the tape and video heads, your Palmcorder's operating modes will revert as follows:
STILL → STANDBY after 5 minutes.
STANDBY → POWER OFF after 5 minutes when using a Battery Pack.
- When the tape reaches its end during playback, or fast forward, it will rewind automatically.

Playback your Recordings

Playback using the PlayPak

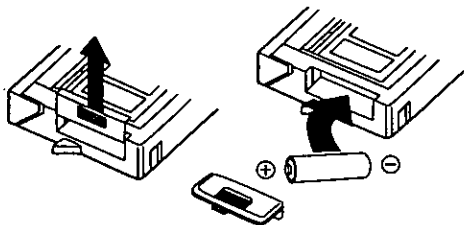

Remove the Battery Compartment lid and insert the AA size battery.

- Make sure polarities are aligned properly.
- When tape loading and unloading time becomes longer than normal, battery replacement is necessary.

Insert VHS Cassette

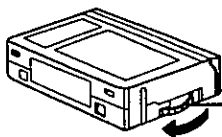

1 Turn the Tape Wheel on the **VHS** cassette in the direction of the arrow to reduce any slack.

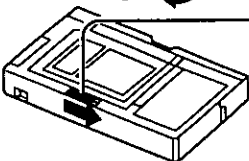

2 Slide the **RELEASE** button in the direction of the arrow to open the PlayPak door.

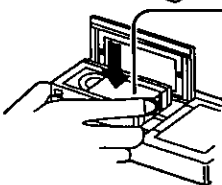

3 Insert the **VHS** cassette with the window facing up and to the left. Then, snap the lid shut.

- Let the Load Detector fully retract before using the PlayPak in your standard VHS VCR.
- Be sure the cassette reel area under the PlayPak is free to turn while loading.

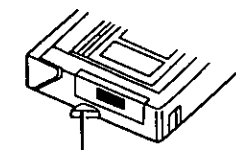

Load Detector

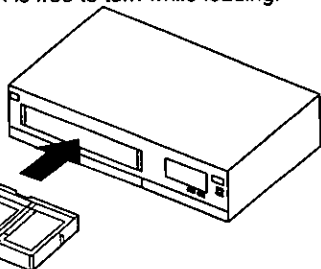

Remove VHS Cassette

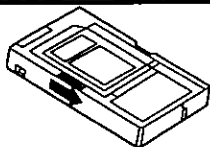

1 Slide the **RELEASE** button and wait for the lid to open.

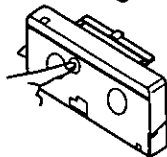

2 Hold the PlayPak securely in one hand. Put your finger through the hole in the bottom of the PlayPak and push the cassette out.

Playback your Recordings

Playback or View on a TV

Your Palmcorder may be connected to a TV to play back tapes or to view what you are recording.

TV with AUDIO/VIDEO IN Jacks.

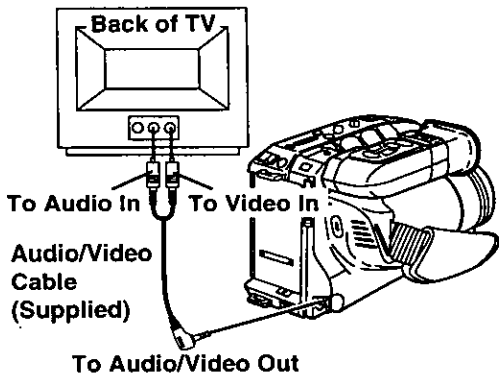

TV without AUDIO/VIDEO IN Jacks.

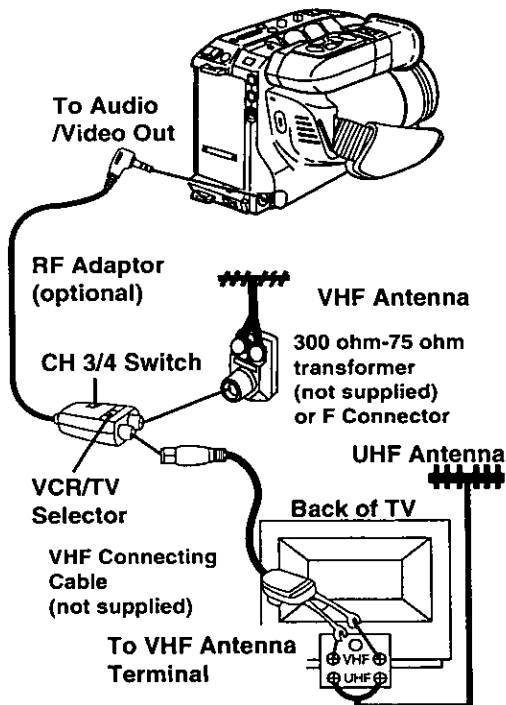

Before you begin...

- Connect the Palmcorder to a power source.

1 Set the **POWER** switch to **VCR** to playback a tape.
Or, set to **CAMERA** to view what your Palmcorder is recording.

2 Turn the TV **ON** and set it to **LINE INPUT**.

Check your TV operating instructions for further information.

Note:

If your TV has no VIDEO or AUDIO IN Jacks, select CH 3 or 4 on your TV to match the RF Adaptor CH 3/4 switch and set the VCR/TV selector on the RF Adaptor to VCR.

3 Start playback or begin a recording.

Basic Operation

To watch TV only

If you have connected the Palmcorder to your TV using an RF Adaptor:
Set the **POWER** switch to **OFF** on the Palmcorder.
Then, set the **VCR/TV Selector** on the RF Adaptor to **TV**.
Now, turn the TV **ON** and select a channel.

CATV System Installer

This reminder is provided to call the CATV system installer's attention to Article 820-40 of the NEC in USA (and to the Canadian Electrical code in Canada) that provides guidelines for proper grounding and, in particular, specifies that the cable ground shall be connected to the grounding system of the building, as close to the point of cable entry as practical.

Special Features

Four-Speed Power Zoom

You can gradually zoom in for close ups or zoom out for wide angle shots.

The zooming speed ranges from a slow speed of 16 seconds to a fast 2 seconds according to the pressure applied to the zoom buttons.

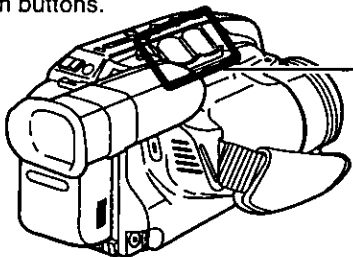

Zoom In ("T")

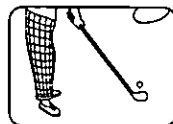

Zoom Out ("W")

Zoom slowly by lightly pressing the "T" (Telephoto) or the "W" (Wide Angle) side of the POWER ZOOM switch.

Zoom quickly by applying more pressure.

- The magnification level is displayed in the EVF.

High Speed Shutter

To record high speed motion (i.e. a tennis stroke) for improved STILL or SLOW mode playback, when watching the tape on this Palmcorder or a VHS VCR (3 or 4 head VCR).

Auto Shutter

In the AUTO mode (no indication in the EVF), the Palmcorder will automatically adjust the shutter speed from 1/60 to 1/250 according to the brightness of the subject. The speed does not appear in the EVF.

- AUTO mode is automatically selected whenever the POWER switch is set to CAMERA.

Manual Selection

The High Speed Shutter indicator flashes when the light level is inadequate. More light should be provided to achieve better picture quality and color.

Press HIGH SPEED SHUTTER while recording.

Press repeatedly to obtain one of the eight higher shutter speeds shown at right.

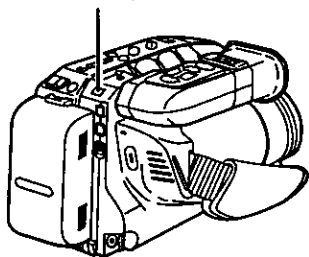

EVF Indications

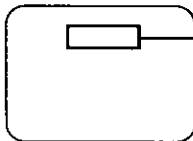

No Indication

1/60

1/100

1/250

1/500

1/1000

1/2000

1/4000

1/10000

Note:

- For proper color reproduction, it is recommended that you use this feature outdoors. For indoor High Speed Shutter recording, additional halogen or tungsten light should be provided. Fluorescent light will degrade the picture quality.
- This feature requires ample light. More light is required for the fastest shutter speeds.
- The Auto Focus system may not operate properly in insufficient light when using the High Speed Shutter.

Special Features

Auto Focus

The Palmcorder will automatically bring the subject into focus even during zooming.

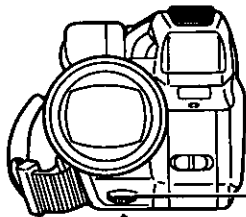

For Auto Focus mode, it may be necessary to press **MANUAL FOCUS**, so that "MF" does not appear in the EVF.

Manual Focus

Use Manual Focus (MF) when recording ...

- a subject through glass.
- a scene where the subject is far from the Palmcorder and there are objects in the foreground.
- a subject with distinct horizontal stripes.
- a subject not centered in the Viewfinder.
- subjects with shiny surfaces.

- an obliquely angled subject.
- a bright, flat subject such as a white wall.
- in low light situations.
- a scene with fast motions, like a golf swing.
- **Re-focusing may be required** when your Palmcorder is aimed at a new scene.

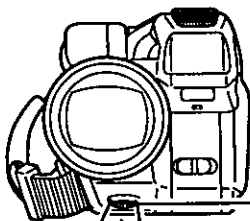

- 1** Press **MANUAL FOCUS** so that "MF" (Manual Focus) appears in the EVF.

EVF Indication

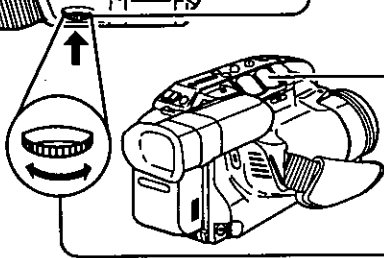
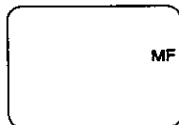

- 2** Press and hold the "T" side of the **POWER ZOOM** switch until the lens is zoomed in all the way (subject at maximum size).

- 3** Rotate **MANUAL FOCUS** until the picture is in focus.
 - It may be necessary to back away from the subject to focus the image properly.

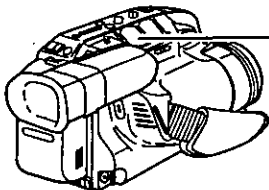

- 4** Press the "W" side of the **POWER ZOOM** switch to frame the picture as desired.

Macro Focus (for close-ups)

Auto Focus will function down to 1/2 inch (12.7mm) in front of the lens.

Press the "W" side of the **POWER ZOOM** switch to the wide angle position. Then, bring the Palmcorder as close to the subject as necessary.

Special Features

Backlight

Use when recording a subject that is darker than the surrounding scene, in a shadowed area or when the light source is in back of your subject.

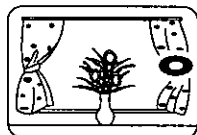
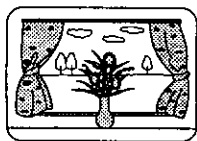

Indication appears in the EVF.

EVF Indications

Normal (no display)



First press (low)



Second press (medium)



Third press (high)

Fourth press

Select one of these positions so that the subject can be seen clearly.

Press **BACKLIGHT** to obtain the desired position while recording.

Press until there is **no display** in the EVF when lighting conditions return to normal.

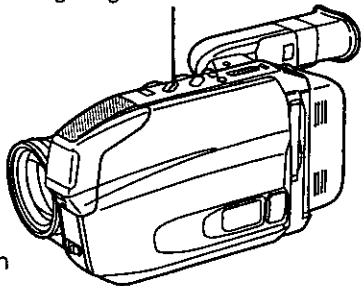

One-Touch Auto Fade (BLACK or WHITE only)

This feature allows you to make smoother scene transitions for a professional look.

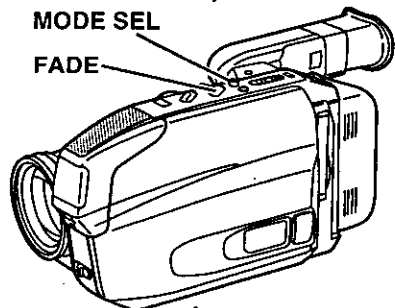

BLACK

WHITE



BLACK

WHITE



FADE

FADE

Fade In

Fade Out

Fade In:

Starting the first scene with "fade in" is very effective.

- 1 Press **MODE SEL** repeatedly to select BLACK or WHITE fade.
- 2 Press **FADE** in Record/Pause mode so that "FADE" flashes in the EVF.
- 3 Press **RECORD/PAUSE** to start recording. The picture and sound fade out, and then will gradually fade in.

Fade Out:

Use to create a soft ending or, when used together with fade in, a soft transition from one scene to the next.

- 1 Press **MODE SEL** repeatedly to select BLACK or WHITE fade.
- 2 Press **FADE** so that "FADE" flashes in the EVF while recording.
- 3 Press **RECORD/PAUSE** to pause recording. The picture and sound gradually fade out.

If **FADE** is accidentally pressed, press again so that "FADE" disappears in the EVF.

Special Features

Color Digital Fade (other than BLACK and WHITE)

This feature offers 7 fade variations in your choice of eight colors for flexibility in the transition from one scene to the next.

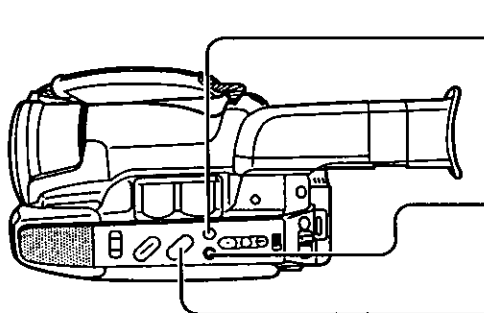

1 Press **MODE SEL** repeatedly to select the desired fade effect other than BLACK and WHITE.

- Other than BLACK, the mode selected will appear in the EVF.

2 Press **COLOR** repeatedly to select the desired Color for Digital Fade effects other than Black and White.

3 Hold the **FADE** button down while recording until the picture fades out. Release to fade back in.

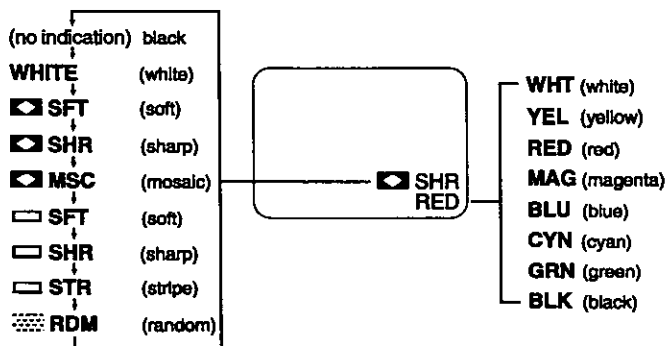

■ To create even more special effects, (other than BLACK, WHITE, and RANDOM modes), you may also partially fade the picture, and by pressing the MODE SEL button, freeze the fade function.

Press FADE again to resume, or press MODE SEL to cancel.

Note:

- Other than BLACK and WHITE modes, the audio is not affected by the fade control.

Special Features

Color Digital Filter

This feature adds any of the six colors to the whole screen just like a color filter. The addition of color will give your recordings special nuance.

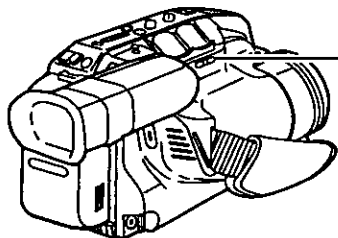

Before you begin...

- Connect the Palmcorder to a power source.
- Set the POWER switch to CAMERA.
- Insert a cassette with record tab (see page 10).

Hold down D. FILTER, NEG/POS for 2 seconds (approx.) to view or record a negative image.

- This filter changes the picture from a positive to a negative image.

Press D. FILTER, NEG/POS repeatedly until the desired color filter appears.

Press D. FILTER, NEG/POS repeatedly until the normal image appears.

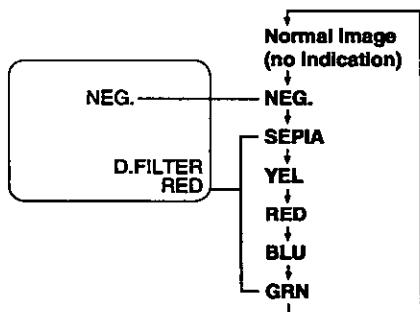

Note:

- During Digital Wipe or Digital Still/Strobe/Wide, the Color Digital Filter will not activate.
- Colored images will revert back to normal image when viewed in still mode.

Digital Zoom

This feature allows you to increase the magnification of the Power Zoom.

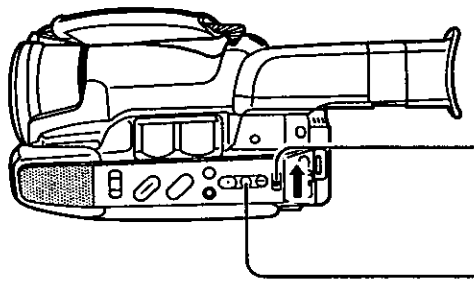

Before you begin...

- Set the POWER switch to CAMERA.

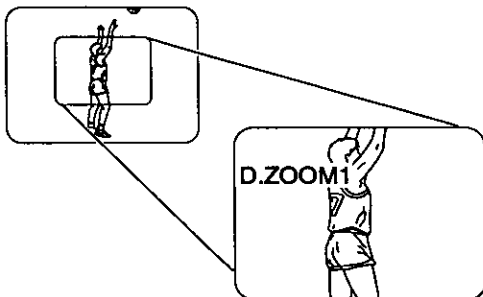

- 1** Slide the DIGITAL SELECT switch to D.ZOOM.

- 2** Press DIGITAL ZOOM to select D.ZOOM 1 for partial increase (32 \times max.) or twice to select D.ZOOM 2 (160 \times max.) for even greater increase.

Because the image is enlarged digitally, the picture may become distorted when higher magnification levels are used.

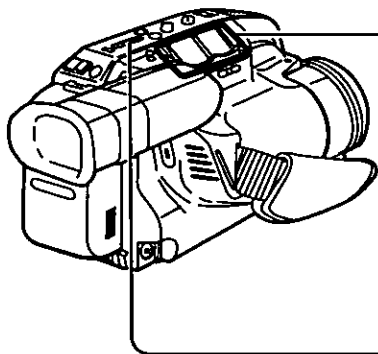

- 3** Press and hold the "T" side of the POWER ZOOM switch. Digital Zoom engages when the Power Zoom reaches its maximum of $\times 16$.

- Zoom level is displayed in the EVF.
- Press the "T" or "W" side of the POWER ZOOM switch to control the digital zoom level.
- When the level falls below $\times 16$, the normal zooming function will resume.

- 4** Press DIGITAL ZOOM until no indication appears in the EVF to turn the Digital Zoom feature off. (The zoom ratio will adjust to 16 \times .) (refer to page 28 for normal zoom operation.)

Special Features

Digital Electronic Image Stabilization System

This feature helps stabilize the picture in situations such as walking or shooting from a moving vehicle.

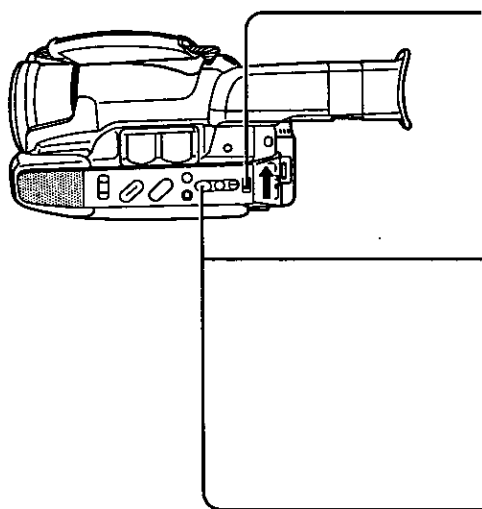

1 Slide the **DIGITAL SELECT** switch to **EIS**

2 Press **EIS** to activate the Digital E.I.S. function. ("EIS" will appear in the EVF.)

- The image in the EVF will be enlarged slightly and the shutter speed will automatically adjust from 1/80 to 1/250 according to the brightness of the subject.

3 Press **EIS** again to cancel.

- You may also use the High Speed Shutter function (from 1/100 to 1/10000). The shutter speed you select remains active even after you cancel the Digital E.I.S. function.
- Be sure that the Digital E.I.S. is turned off when not in use.

Digital E.I.S. may not function when...

- Palmcorder movement is too extreme.
- recording a subject with distinct horizontal or vertical stripes.
- recording in low light situations.
- EIS indicator flashes when the light level is inadequate.
- recording a subject under intense fluorescent light.
- recording a scene with very fast motions.



NORMAL

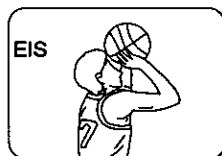

Digital EIS ON

Still/Strobe/Wide

Slide the DIGITAL SELECT switch to STILL/STROBE.

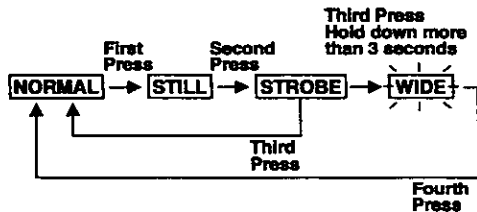
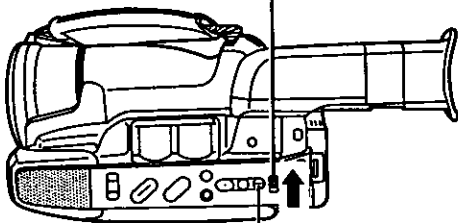

Still

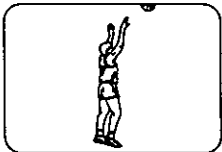

Still

Use this feature to record a still image from the current camera picture.

Press STILL/STROBE once.

Press twice more to return to normal recording.

Strobe

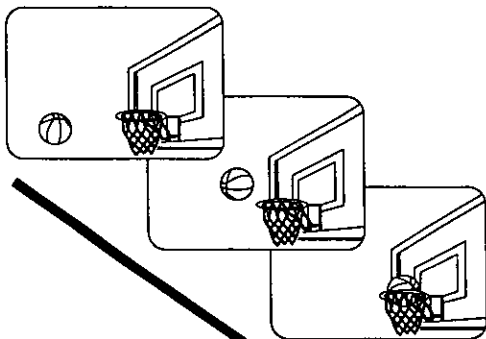

Strobe

Use this feature to record a strobing progression of still images, (in 1/6 of a second intervals).

Press STILL/STROBE twice.

Press once more to return to normal recording.

Wide Screen

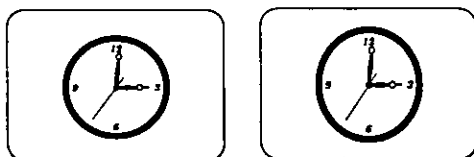

Normal

Wide

Wide Screen

Use this feature to fill the entire screen of your Wide Screen TV.

Hold down STILL/STROBE more than 3 seconds while in Strobe mode (see above).

Press once again to return to normal sized picture recording.

Note:

- Wide screen recordings must be played back using a wide screen (16x9 aspect ratio) TV or the picture will appear distorted.
- If you add titles (see page 38) while recording in Wide mode, they will appear distorted when played back on a wide screen (16x9 aspect ratio) TV.

Special Features

Digital Wipe

This feature makes it possible to replace the current recorded scene with a memorized scene.

- 1** Slide the **DIGITAL SELECT** switch to **DIGITAL WIPE**.

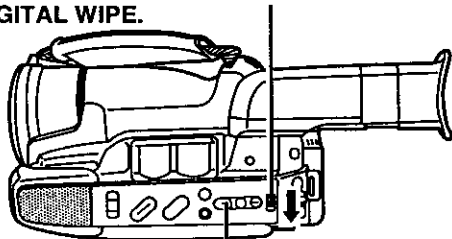

- 2** Press **MEMORY** in **Record/Pause mode** to memorize the desired scene.
- The picture fades out and then fades in. The memorized scene is displayed in the EVF for one second and "MEM." is displayed while scene is memorized.
 - The **MEMORY** button does not function while recording or when a scene from memory is being displayed.

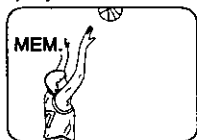

- 3** Press **MODE** repeatedly to select the desired effect for Wipe.

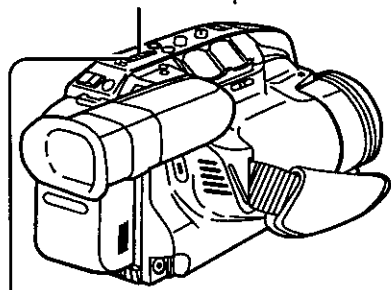

- 4** Press **START** to start the effect. The memorized scene gradually replaces the current recording. If **START** is pressed one more, the current recording will gradually replace the memorized scene.

- While wipe is in progress, you can freeze the wipe by pressing **START**. Press **START** again to continue **WIPE**.

Press **MODE** Button

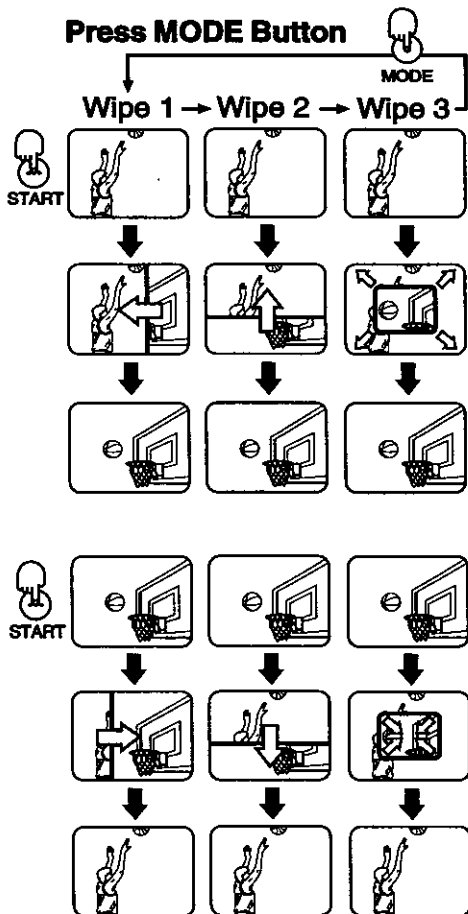

Note:

- The memorized scene will be cleared when **Palmcorder** is turned off.

Motion Detection (Motion Sensor)

Great for amateur surveillance applications.

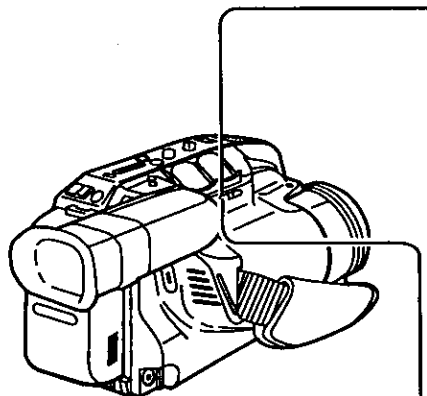

Before you begin...

- Connect the Palmcorder to a power source. For extended periods of recording, it is recommended to use the AC Adaptor for a power source.
- Insert a cassette with record tab (see page 10).
- Set the POWER switch to CAMERA

1 In Record/Pause mode, hold down **MOTION DETECT** for 2 seconds (approx.) to set the Palmcorder in Motion Detection stand-by mode. (If no cassette tape is inserted, "REC" will flash.)

MOTION
DETECTION
STAND-BY

- Palmcorder will start recording approximately 3 seconds after it perceives motion.

MOTION
DETECTION

- When motion ceases, recording will stop 30 seconds later.

MOTION
DETECTION
STAND-BY

2 Press **MOTION DETECT** again to cancel the Motion Detection feature.

Note:

- Make sure the Palmcorder is firmly secure. If the Palmcorder is moved, the Motion Detection feature will start, regardless of the subject being recorded.
- While recording, Palmcorder will not be set in Motion Detection stand-by mode.
- While Palmcorder is in motion detection stand-by mode, Record/Pause, Stand-by mode, Digital E.I.S., Color Digital Fade, One-Touch Auto Fade and Negative/Positive Transposer can not be activated.

Motion Detection may function regardless of the subject's motion when:

- the background is plain, such as a white wall.
- recording a subject with distinct horizontal, vertical or oblique stripes, such as a window shade.
- the brightness suddenly changes.

Motion Detection may not function when...

- motion is very slow or very fast.
- moving object is very small.
- motion is in 1 corner of the viewing area.
- in low light situations (MOTION DETECTION will flash if the light level is inadequate.)
- the background has distinct horizontal or vertical stripes.
- the background is plain, such as a white wall.

Special Features

Intelligent Titler

On specific holidays, such as New Year's Day, the Palmcorder will automatically display the appropriate title (except HAPPY EASTER and PRESIDENT'S DAY) from the pre-programmed titles when the Palmcorder is turned on in the Camera mode on that day.

Automatic Title Display

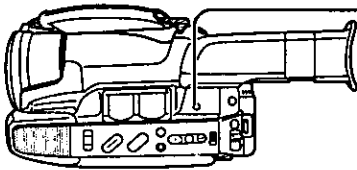

Before you begin...

- Connect the Palmcorder to a power source.
- Insert a cassette with record tab (see page 10).

Press **RECORD/ PAUSE** to record the displayed title.

Press **TITLE** in Record/Pause mode to erase or redisplay the title.

Note:

If you erase the title and then turn the Palmcorder off, the title will not be automatically displayed when the power is turned back on.

Dec. 31–Jan. 1	HAPPY NEW YEAR! / CHEERS!
Feb. 14	VALENTINE'S DAY / BE MY VALENTINE
2nd Sunday in May	HAPPY MOTHER'S DAY / WE LOVE YOU!
Last Monday in May	MEMORIAL DAY
3rd Sunday in Jun.	HAPPY FATHER'S DAY
Jul. 4	INDEPENDENCE DAY
1st Monday in Sep.	LABOR DAY
Oct. 31	HAPPY HALLOWEEN
4th Thursday in Nov.	HAPPY THANKSGIVING
Dec. 24–25	MERRY CHRISTMAS / HO! HO! HO!
These Titles must be displayed manually.	HAPPY EASTER PRESIDENT'S DAY

Manual Title Display

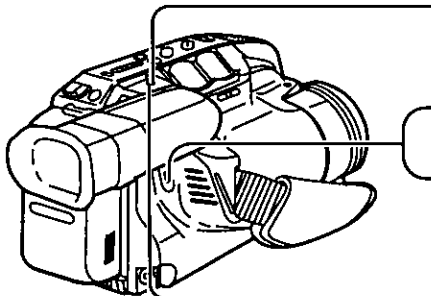

- 1** In Record/Pause mode, Press **TITLE** repeatedly to display the desired title from the list show above.
- 2** Press **RECORD/PAUSE** to record the displayed title.
- 3** Press **RECORD/PAUSE** again to pause the recording.
- 4** Press **TITLE** repeatedly until no title appears on-screen.

Copying your Tapes (dubbing)

Main Operation

Before you begin...

- Connect the Palmcorder as shown below.
- Connect the Palmcorder to VCR.
- Turn ON both units.
- Set the recording VCR's Input Signal Selector to LINE.
- Set the Palmcorder POWER switch to VCR.

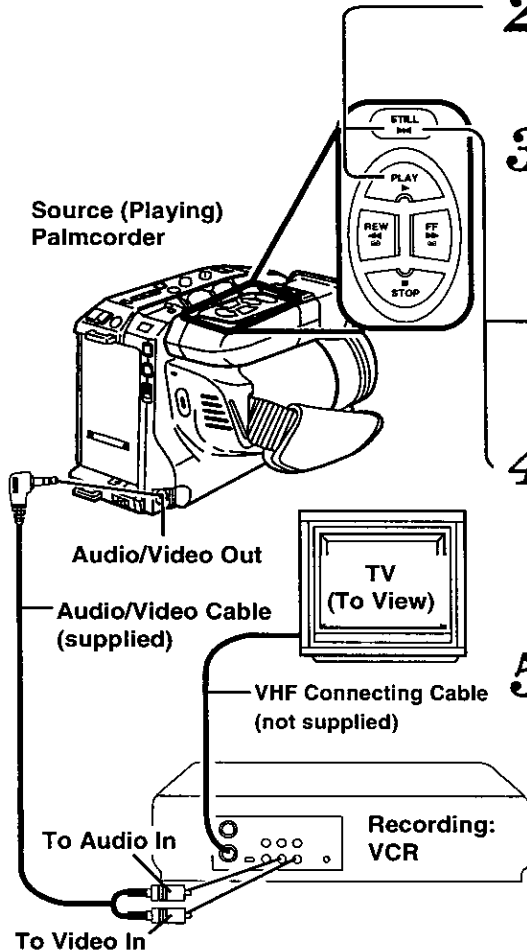

To Video In

Monitor with your TV

- Turn the TV ON and select its VCR channel (either CH3 or CH4).
- Set the VCR/TV Selector on the recording VCR to VCR.

- 1** Insert a pre-recorded tape into the source (playing) Palmcorder and a blank tape with record tab into the recording unit.
- 2** Press **PLAY** on the (playing) Palmcorder. Press **STILL** when the tape reaches the point you want to start dubbing.
- 3** Press **PLAY** and **REC** together then immediately press **STILL** on the recording unit.



VCR Buttons

- 4** Press **STILL** on the playing Palmcorder and **PAUSE/STILL** on the recording unit to begin copying your tape.
- 5** Press **STOP** on both units when dubbing is complete.

Note:

- Tapes recorded on other VCRs and used for playback in the Palmcorder must be recorded in SP or SLP mode.
- For technical reasons, dubbing a tape may reduce its quality.

CAUTION:

Unauthorized exchanging and/or copying of copyrighted recordings may be copyright infringement.

Palmcorder Accessory System

For information and ordering instructions, see the separate Selection Guide and Accessory Order Form.

Power Supplies

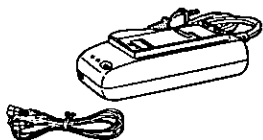

AC Adaptor with
DC Power Cable
Supplied (PV-A17)
Optional (PV-A17)



1.8Ah Battery Pack
Supplied (PV-BP18)
Optional (PV-BP18)



2.4Ah Battery Pack
Optional (PV-BP17)



1.2Ah Battery Pack
Optional (PV-BP15)



Car Battery Cord
Optional (PV-C16)

To Transport



Shoulder Strap
Supplied (VYCW0108)

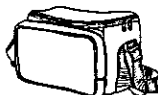

System Carrying Case
Optional (PV-H18)

Connection



Audio/Video Cable
Supplied (VJAW0032)



RF Adaptor
Optional (PV-RF16)

To Record and Playback

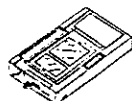

VHS PlayPak
Supplied (PV-P1
/VYMW0009)
Optional (PV-P1)

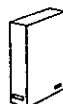

Compact Video
Cassette Tape
Optional
(NV-TC20P,
NV-TC30P,
NV-TC40P)

For Special Effects

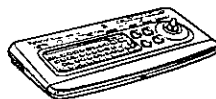

Video Corrector
Optional (PV-CC50)

To Copy your Tapes (with Video/Audio)



Audio/Video Cable
Supplied (VJAW0032)

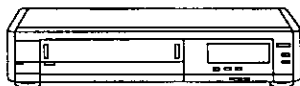

VCR (not supplied)

Notes Regarding Operations

Attaching Optical Filters and Lenses

Attach an optical filter or lens.

- Be careful not to touch the lens itself.

Cleaning the EVF (Electronic View Finder)

To Remove

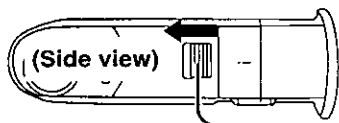

1 Slide and hold the EYEPIECE RELEASE button.

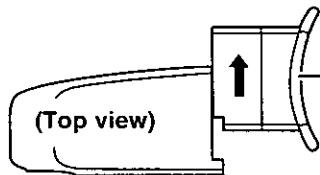

2 Remove the eyepiece. (Do not twist.)

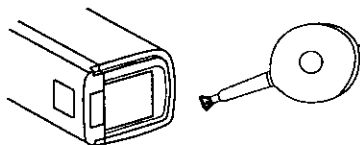

3 Remove any lint or dust particles with a blower, available at photography stores. Do not touch lenses with fingers. Now, replace the eyepiece.

FCC Warning: Any unauthorized changes or modifications to this equipment would void the user's authority to operate.

This device complies with Part 15 of the FCC Rules. Operation is subject to the following two conditions: (1) This device may not cause harmful interference, and (2) this device must accept any interference received, including interference that may cause undesired operation.

Note: This equipment has been tested and found to comply with Part 15 and part 18 of the FCC Rules. These limits are designed to provide reasonable protection against harmful interference when operated in a residential environment.

If this equipment does cause interference to radio or television reception, which can be determined by turning the equipment off and on, use the equipment in another location and/or utilize an electrical outlet different from that used by the receiver.

If necessary, consult the dealer or an experienced radio/TV technician for help. You may find the booklet, 'Something About Interference' available from FCC local regional offices helpful.

Specifications

Power Source:	Compact VHS Palmcorder: DC 6V AC Adaptor: 110/120/220/240V AC, 50/60 Hz Battery: Nickel-Cadmium Type DC 6V
Power Consumption:	Compact VHS Palmcorder: 6V DC 8.1W (Max. 11.1 W) AC Adaptor: 24W 1.2W (when not in use.)
Video Signal:	EIA Standard (525 lines, 60 fields) NTSC color signal
Video Recording System:	4 rotary heads, helical scanning system
Audio:	1 track
Pick-Up System:	Sequential color difference field reverse system
Pick-Up Device:	One integral color filter Charge Coupled Device (CCD)
Lens:	16:1 zoom lens, F1:1.6 with auto iris control Focal length: 5.3mm - 84.8mm Power zoom function Lens filter diameter: 58mm
Viewfinder:	0.5 inch (12.7mm) Liquid Crystal Color Electronic Viewfinder
Minimum Illumination Required:	1 lx (F1:1.6) 0.1 footcandles
Operating Temperature:	32°F-104°F (0°C-40°C)
Operating Humidity:	10%-75%
Weight:	Compact VHS Palmcorder: 2.0 lbs. 0.93 kg AC Adaptor: 0.77 lbs. 0.35 kg
Dimensions:	Compact VHS Palmcorder: 4-1/4 (W) × 4-5/8 (H) × 7 (D) inch 109 (W) × 116 (H) × 177 (D) mm AC Adaptor: 2-3/4 (W) × 1-5/8 (H) × 5-3/4 (D) inch 70 (W) × 41 (H) × 145 (D) mm

Weight and dimensions shown are approximate.
Designs and specifications are subject to change without notice.

Before Requesting Service

Cleaning Care for Video Heads



Clogged Video Head

(a) **Video Head Cleaning:** Your Palmcorder will not normally require head cleaning; however, it is possible that the heads may become clogged when playing an old or damaged tape. If the image on your screen resembles the photograph on the left while playing back a tape, the heads may require cleaning.

(b) **Cleaning the Heads:** It is recommended that head cleaning be performed by a qualified service technician. Please contact your nearest Panasonic Service Center. An alternate solution is to obtain a head cleaning cassette. There are many types of cleaning cassettes, so be sure to follow the cleaning instructions carefully. Excessive use of the cleaning cassette could shorten head life.

Use this cassette only when a head clogging symptom occurs.

Refer servicing to qualified service personnel.

Auto-Reset

The Palmcorder, provided no tape is inserted, will reset the Backlight, High Speed Shutter and Focus to their AUTO or OFF modes if, after activation, none of these buttons are pressed within 5 minutes.

Before Requesting Service

If you have a problem with your Palmcorder, it may be something you can correct yourself. Check the list below for symptoms and corrections.

Symptom	Correction
No picture in the EVF ...	<ul style="list-style-type: none"> • Make sure a Power Source is connected. (pp. 7, 9) • Make sure the POWER switch is set to VCR or CAMERA. (pp. 20, 25) • Check the Dew Indicator. (p. 17) • Make sure the battery is fully charged. (p. 7) • Make sure all necessary cables are connected correctly and firmly. (p. 27)
Video cassette can't be inserted ...	<ul style="list-style-type: none"> • Make sure a Power Source is connected. (pp. 7, 9) • Insert the cassette with the window side facing out. (p. 10)
Video cassette can't be removed ...	<ul style="list-style-type: none"> • Make sure a Power Source is connected. (pp. 7, 9)
No operation starts when operation buttons are pressed ...	<ul style="list-style-type: none"> • Check the Dew Indicator. (p. 17)
Recording cannot be done ...	<ul style="list-style-type: none"> • Make sure the record tab is still intact. (p. 10) • Check the Battery Indicator. (p. 15) • Check the Dew Indicator. (p. 17)
Auto Focus does not operate ...	<ul style="list-style-type: none"> • Make sure the FOCUS button is set to AUTO. (p. 29) • Make sure the unit is ON, with the POWER switch set to CAMERA (p. 20).
Sound from microphone can't be monitored ...	<ul style="list-style-type: none"> • Make sure the unit is set to REC or Record/Pause mode.
Camera picture is too dark ...	<ul style="list-style-type: none"> • Make sure the HIGH SPEED SHUTTER button is OFF (p. 28).
No playback picture, or the playback picture is noisy or contains streaks ...	<ul style="list-style-type: none"> • Press the Clock Set UP ▲/DOWN ▼ button during playback (Tracking Control) (p. 25).
During playback, the picture shows motion or blurred action ...	<ul style="list-style-type: none"> • Portions of the still picture where the normal speed motion was particularly rapid may produce this effect. This is normal.
"Panasonic Palmcorder IT'S VHS! SO ITS TAPES PLAY IN YOUR VCR" appears in the EVF and Monitor ...	<ul style="list-style-type: none"> • Set the POWER switch to OFF and then CAMERA.
If the top of your playback picture waves back and forth excessively ...	<ul style="list-style-type: none"> • Because the playback signal is not as stable as an off the air TV signal, the top of your TV screen may be bent or unstable when the tape is played back. This symptom is more noticeable when a tape, recorded on another VCR, is played back. To solve this problem, locate the horizontal hold control on your TV. Turn it slowly to correct the wavy picture. If your TV does not have a horizontal hold control or adjusting the control does not help, some modifications may have to be made to the TV set. Technically this is called "Horizontal AFC time constant change." If such a problem exists, please contact your local TV service center. (Some nominal service charges may be required.)

Index of Controls

Front View

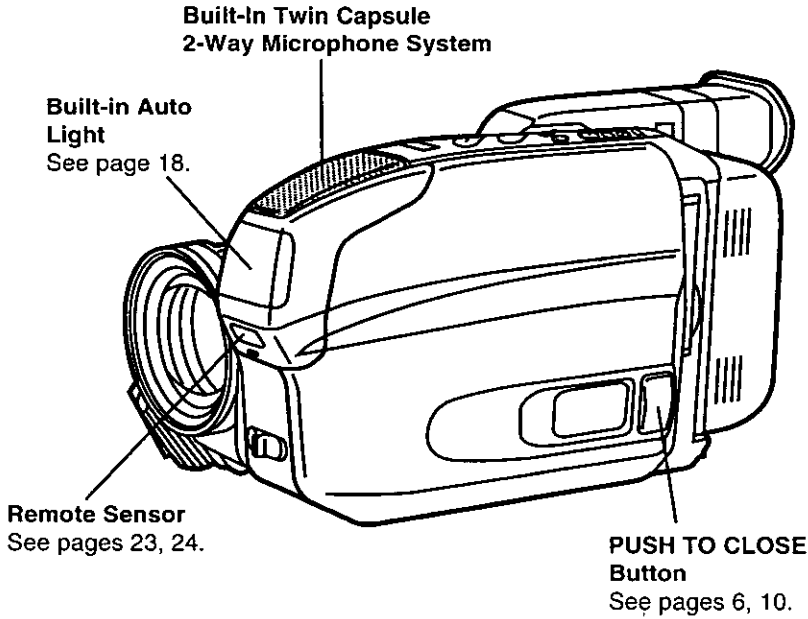

Built-In Lens Cover
Opens automatically when
the Power Switch is set to
CAMERA.
See page 20.

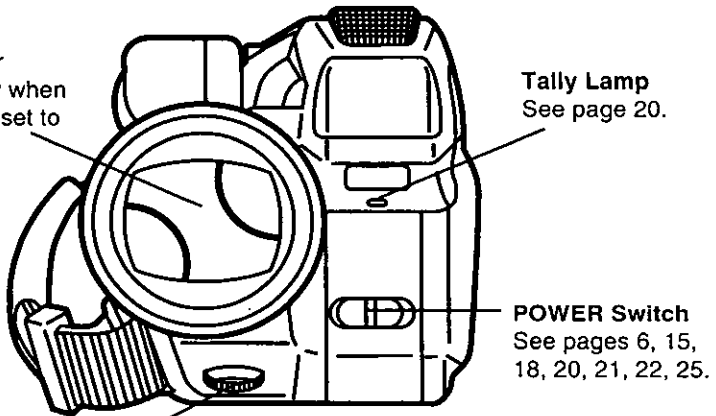

**MANUAL FOCUS
Wheel**
See page 29.

Index of Controls

Rear View

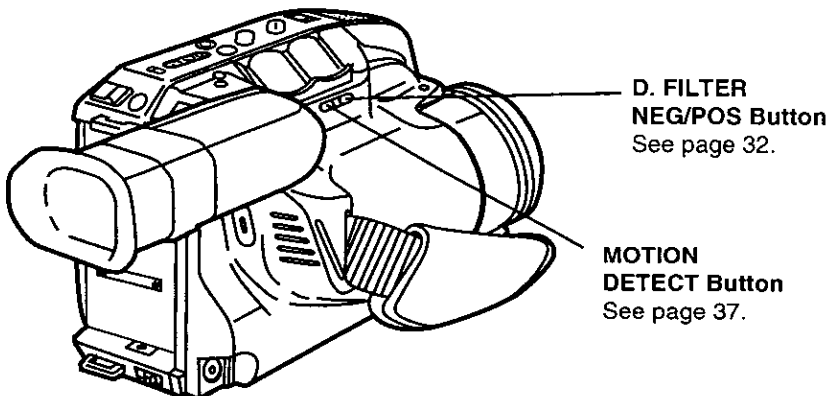
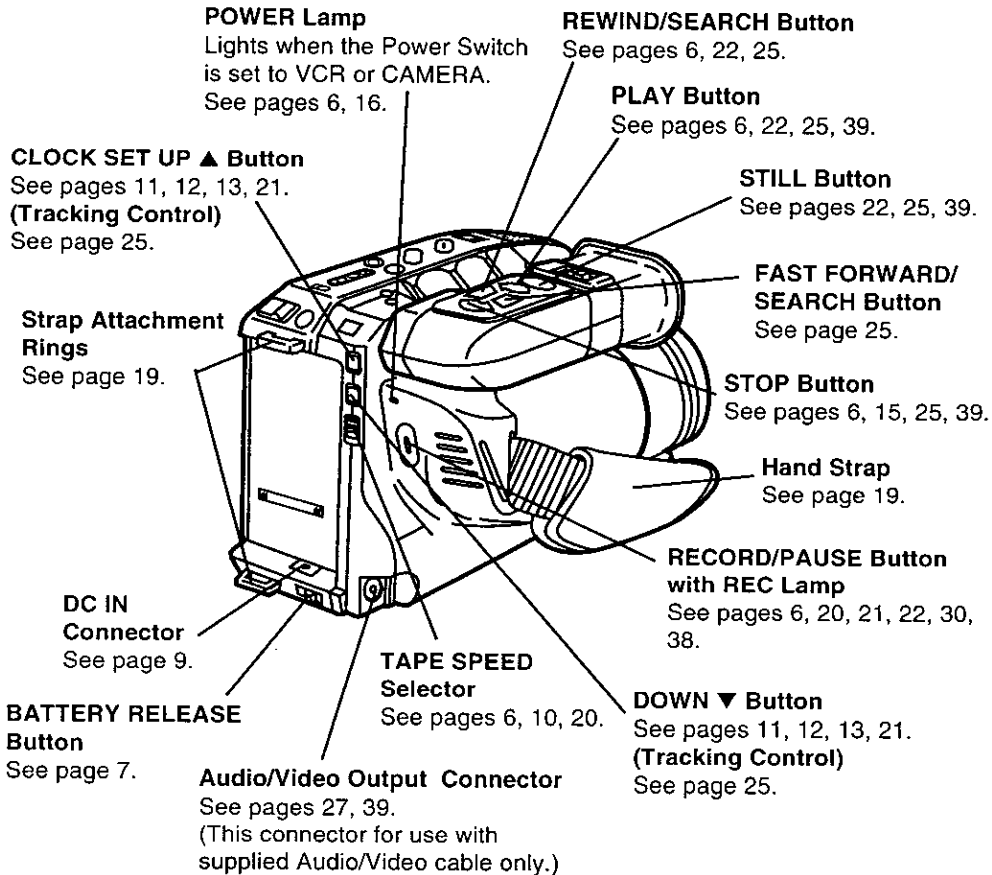

Index of Controls

Top View

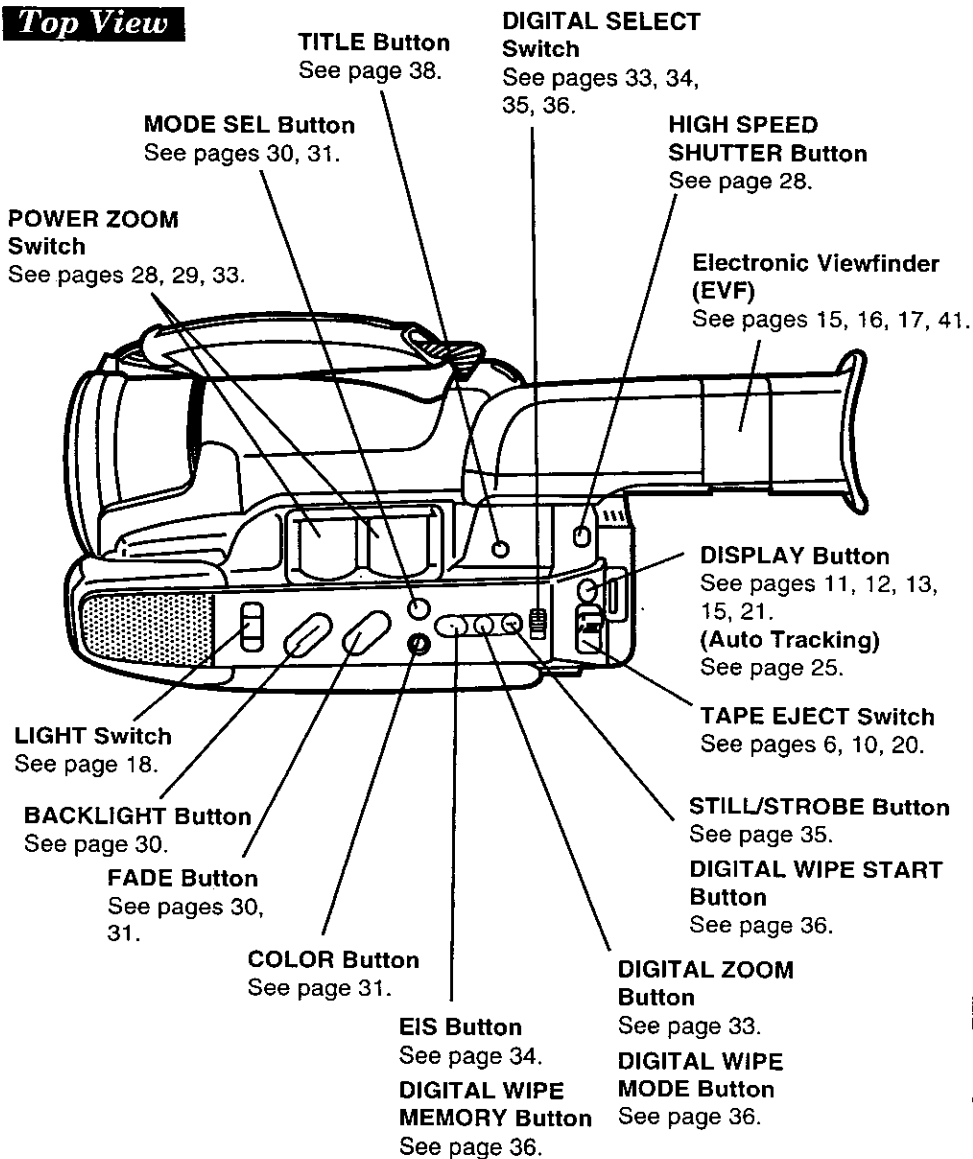

For Your Information

Index of Controls

Underside View

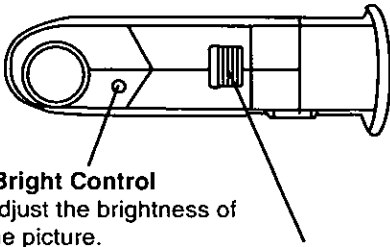
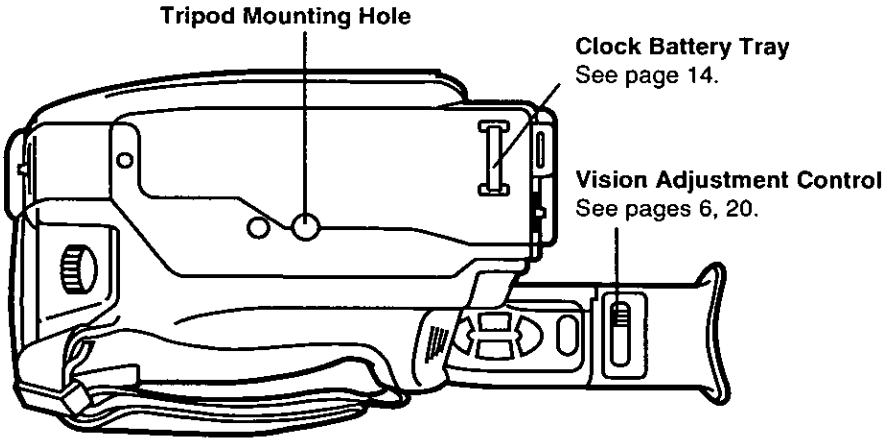

***Note:** These controls have been set at the factory. It is not necessary to adjust these controls under normal circumstances. But, should it become necessary, be careful to make the adjustment with a small, slender screwdriver so as not to damage the miniature control.

Index of Controls

9-Function Remote

POWER ZOOM Switch
See page 23.

REWIND/SEARCH Button
See page 23.

PLAY Button
See page 23.

STOP Button
See page 23.

STANDBY Button
See page 24.

RECORD/PAUSE Button
See pages 23, 24.

FAST FORWARD/SEARCH Button
See page 23.

STILL Button
See page 23.
OTR Button
See page 24.

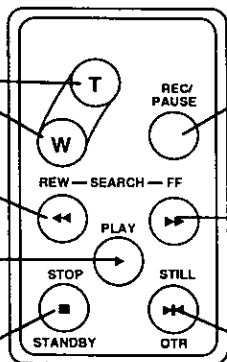

AC Adaptor

CHARGE Lamp
See pages 7, 8.

POWER Lamp
See pages 7, 9.

AC Power Cord
See pages 7, 8, 9.

VCR DC OUT Connector
See page 9.

Battery Charging Compartment
See page 7.

BATTERY REFRESH Button
See page 8.

CAUTION:

This unit will operate on 110/120/220/240V AC. An AC plug adaptor may be required for voltages other than 120V AC. Please contact either a local or foreign electrical parts distributor for assistance in selecting an alternate AC plug. We recommend using the accessory power plug adaptor (VJSS0070) in an area which has special AC outlets.

Index

- A**
Accessories (Optional/Supplied) 2, 40
AC Adaptor 9
Audio/Video Cable 2, 27, 39, 40
Auto Daylight Saving Time 12
Auto Focus 29
Auto-Reset 43
- B**
Backlight 30
Battery Pack 2, 7, 8, 40
Battery Remaining Indication 15, 16
Battery Warning 16
- C**
Camera Recording 20
Car Battery Cord 9, 40
CH 3/4 Switch 27
Charging Battery 7
Cleaning Care for Video Heads 43
Clock Battery 2, 14
Color Digital Fade 31
Color Digital Filter 32
Clock Set 11, 12, 13, 14
Copying your Tapes 39
- D**
DC Power Cable 2, 9, 40
Dew Indication 17
Digital E.I.S. 34
Digital Wipe 36
Digital Zoom 33
Display-off Mode 15
- E**
Easy Edit Stand-by 22
Erase Protection Tab 10
EVF Indications 15, 16, 17
- H**
High Speed Shutter 28
High Speed Shutter Indicator 17, 28
- L**
Light 18
- M**
Macro Focus 29
Manual Focus 29
Motion Detection (MotionSensor) 37
- O**
One-Touch Auto Fade 30
- P**
Play Indicator 16
Playback 25
PlayPak 26
Power Supply 7, 8, 9
Programmed Recording 24
- R**
Rec Indicator 16
Remote Control 23, 24
RF Adaptor 27, 40
- S**
Safety Precautions 2
Search Speed 25
Shoulder Strap 2, 19, 40
Special Effects Playback 25
Specifications 42
Stand-by Release 21
Still Picture 25
Still/Strobe/Wide 35
Symptom/Correction 44
- T**
Tape Speed 10
Tape Warning 16
10-Second Reminder 16
Titler 38
Tracking Control 25
- V**
VCR-MODE Indication 17
VHF Connecting Cable 27, 39
Video Cassettes (tapes) 10, 40
Viewing 27
- Z**
Zoom In/Out 28

Spanish Quick Use Guide/Guía Para Uso Rápido

PREPARATIVOS

- Conectar la videocámara a una fuente de alimentación (batería, adaptador de CA o cable para batería de coche).
- Encender el aparato.
- Introducir el casete en el compartimiento de casetes.

GRABACION

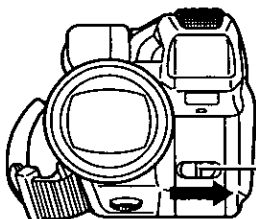

- 1** Fije el interruptor a la posición de CAMERA.

PAUSE

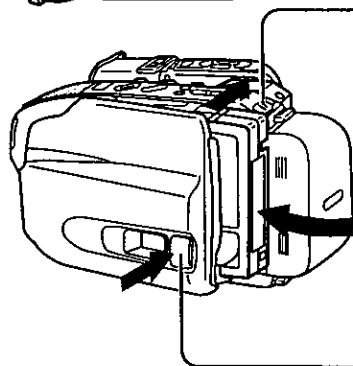

- 2** Deslice el botón EJECT para abrir la puerta.

PAUSE

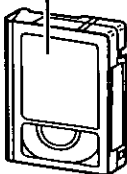

- 3** Introduzca la cinta.

- 4** Cierre la puerta presionando el botón PUSH TO CLOSE.

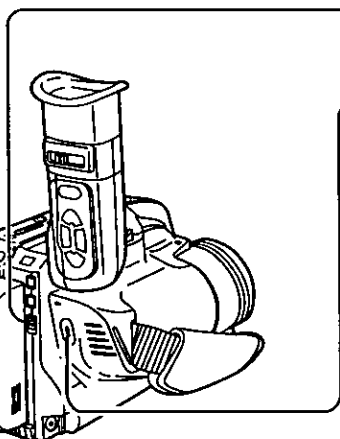

- 5** Seleccionar la velocidad de grabación.

- 6** Oprimir el botón de grabación/pausa (RECORD/PAUSE) para comenzar a filmar.

REC

- 7** Volver a oprimir el botón de grabación/pausa (RECORD/PAUSE) cuando se desea hacer una pausa en la grabación.

PAUSE

Spanish Quick Use Guide/Guía Para Uso Rápido

- Conectar la videocámara a una fuente de alimentación (batería, adaptador de CA o cable para batería de coche).
- Encender el aparato.
- Introducir el casete en el compartimiento de casetes.

REPRODUCCION NORMAL

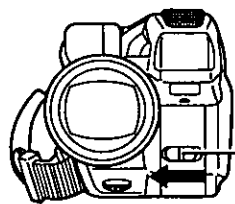

1 Fije el interruptor a la posición de VCR.

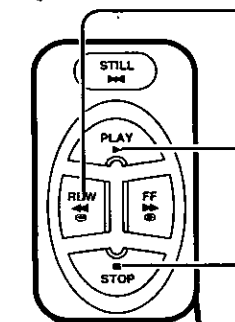

2 Rebobinar la cinta con el botón de rebobinado (REWIND) (si fuera necesario).

3 Oprimir el botón de reproducción (PLAY) para que aparezcan las imágenes en la pantalla.

4 Oprimir el botón de parada (STOP) cuando se desea parar la reproducción.

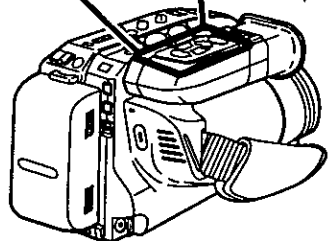

En el visor

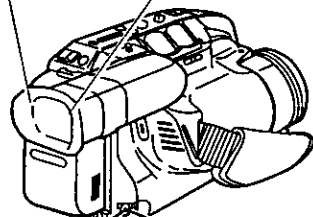

En la TV



REPRODUCCION CON EFECTOS ESPECIALES

PARA LOCALIZAR RAPIDAMENTE UNA ESCENA ESPECIFICA

- Oprimir el botón de localización (SEARCH).

PARA CONGELAR UNA IMAGEN

- Oprimir el botón de pausa/imagen fija (PAUSE/STILL).
- Oprimir nuevamente el botón cuando se desea continuar reproduciendo.

Matsushita Consumer Electronics Company, Division of Matsushita Electric Corporation of America
One Panasonic Way Secaucus, New Jersey 07094

Panasonic Sales Company, Division of Matsushita Electric of Puerto Rico, Inc. ("PSC")
Ave. 65 de Infantería, Km. 9.5 San Gabriel Industrial Park Carolina, Puerto Rico 00985